

# Molex 43650-0316 PDF

深圳创唯电子有限公司

<http://www.molex-connect.com>



# PRODUCT SPECIFICATION

## MICRO-FIT SINGLE ROW CONNECTOR SYSTEM

### 1.0 SCOPE

This Product Specification covers the performance requirements and test methods of Micro-Fit 3.00 mm (.118 inch) centerline (pitch) wire to board and wire to wire connector systems terminated with 18 to 30 AWG stranded wire using crimp technology with tin or gold plating.

### 2.0 PRODUCT DESCRIPTION

#### 2.1 PRODUCT NAME AND SERIES NUMBERS

Receptacle: 43645                      Female Crimp Terminal: 43030  
TPA Receptacle: 171850              Male Crimp Terminal: 43031  
TPA Plug: 200875  
Plug: 43640  
Headers: 43650  
Test Plug: 44242 (recommended for continuity testing only)  
Other products conforming to this specification are noted on the individual drawings.

#### 2.2 DIMENSIONS, MATERIALS, PLATINGS AND MARKINGS

Housings: Receptacle and Plug - Polyester, Nylon; Headers - LCP  
Crimp Terminals: Phosphor Bronze  
Pins: Brass

#### 2.3 SAFETY AGENCY APPROVALS

UL File Number: E29179  
CSA: LR19980  
*IEC 61984 Certification: Tested to and found in compliance with IEC 61984. NRTL type examination certificate available from Molex upon request. Contact Molex Safety Agency team for questions regarding certification on specific part numbers.*

### 3.0 APPLICABLE DOCUMENTS AND SPECIFICATIONS

Test Summary: TS-43045-001  
Application Spec: AS-45499-001 (moisturizing nylon parts)

### 4.0 RATINGS

#### 4.1 SAFETY AGENCY RATINGS

Series	Agency Voltage Rating (AC RMS or DC)			Agency Current Rating (Single Circuit) (Amps)		
	UL	CSA	IEC	UL	CSA	IEC
43640	250	600	250	5	7	5
200875	250	600	250	5	7	5
43645	600	600	250	8	8	5
43650	600	600	250	8	8	5
171850	600	600	250	5	7	5

(Current ratings are maximum and may vary depending on wire size, circuit count, and end-use application. Further testing may be required in the end-use application.)

REVISION: <b>N</b>	ECR/ECN INFORMATION: EC No: <b>UCP2018-0645</b> DATE: <b>2017/10/27</b>	TITLE: <b>PRODUCT SPECIFICATION MICRO-FIT SINGLE ROW CONNECTORS</b>	SHEET No. <b>1 of 9</b>
DOCUMENT NUMBER: <b>PS-43650</b>	CREATED / REVISED BY: <b>SSOUSEK</b>	CHECKED BY: <b>JBELL</b>	APPROVED BY: <b>FSMITH</b>



# PRODUCT SPECIFICATION

## 4.2 CURRENT DERATING AND APPLICABLE WIRES

Current is dependent on connector size, contact material, plating, ambient temperature, printed circuit board characteristics and related factors. Actual current rating is application dependent and should be evaluated for each application.

<u>Stranded Copper Wire Size</u>	<u>Max. Outside Insulation Diameter</u>
18 AWG	1.85 mm (.073 inch)
0.75 mm <sup>2</sup>	1.85 mm (.073 inch)
20 AWG	1.85 mm (.073 inch)
22 AWG	1.85 mm (.073 inch)
24 AWG	1.85 mm (.073 inch)
26 AWG	1.27 mm (.050 inch)
28 AWG	1.27 mm (.050 inch)
30 AWG	1.27 mm (.050 inch)

CURRENT DERATING REFERENCE INFORMATION						
AWG and Metric Wire Size	2-circuit		6-circuit		12-circuit	
	W-W	W-B	W-W	W-B	W-W	W-B
	Amps	Amps	Amps	Amps	Amps	Amps
18	7	8.5	6.5	7	6.5	6.5
20 AWG or 0.75mm <sup>2</sup>	6.5	7	5	* 5.5	4.5	* 5
22	5.5	* 6	* 4	* 4.5	* 3.5	* 4
24	5	5.5	4	* 4.5	3	* 3.5
26	4	4.5	3	* 4	2.5	* 3.5
28	3	* 4	* 2	* 3	* 2	* 3
30	3	3.5	2	* 3	2	* 2.5

- 1) Values are for REFERENCE ONLY.
- 2) Current de-ratings are based on not exceeding 30°C Temperature Rise.
- 3) Testing conducted using tinned stranded copper wire and tin plated terminals.
- 4) PCB trace design can greatly affect temperature rise results in Wire-to-Board applications.
- 5) Data is for all circuits powered.
- 6) \* indicates interpolated information.
- 7) **W-W**: Wire-to-Wire      **W-B**: Wire-to-Board

REVISION: <b>N</b>	ECR/ECN INFORMATION: EC No: <b>UCP2018-0645</b> DATE: <b>2017/10/27</b>	TITLE: <b>PRODUCT SPECIFICATION MICRO-FIT SINGLE ROW CONNECTORS</b>	SHEET No. <b>2 of 9</b>
DOCUMENT NUMBER: <b>PS-43650</b>	CREATED / REVISED BY: <b>SSOUSEK</b>	CHECKED BY: <b>JBELL</b>	APPROVED BY: <b>FSMITH</b>



# PRODUCT SPECIFICATION

## 4.3 CURRENT FOR TEST PLUG 44242

2.5 Amps Maximum (Pogo pin current capacity)

Test plugs are for testing purposes only and not intended for continuous use.

## 4.4 TEMPERATURE

Operating: - 40°C to + 105°C (Including Terminal Temperature Rise)

Nonoperating: - 40°C to + 105°C

REVISION: <b>N</b>	ECR/ECN INFORMATION: EC No: <b>UCP2018-0645</b> DATE: <b>2017/10/27</b>	TITLE: <b>PRODUCT SPECIFICATION MICRO-FIT SINGLE ROW CONNECTORS</b>	SHEET No. <b>3 of 9</b>
DOCUMENT NUMBER: <b>PS-43650</b>	CREATED / REVISED BY: <b>SSOUSEK</b>	CHECKED BY: <b>JBELL</b>	APPROVED BY: <b>FSMITH</b>



# PRODUCT SPECIFICATION

## 5.0 PERFORMANCE

### 5.1 ELECTRICAL REQUIREMENTS

DESCRIPTION	TEST CONDITION	REQUIREMENT
<b>Contact Resistance (Low Level)</b>	Mate connectors: apply a maximum voltage of 20 mV and a current of 100 mA. (Does not include wire resistance)	10 milliohms MAXIMUM [initial]
<b>Contact Resistance of Wire Termination (Low Level)</b>	Terminate the applicable wire to the terminal and measure wire using a voltage of 20 mV and a current of 100 mA.	5 milliohms MAXIMUM [initial]
<b>Insulation Resistance</b>	Unmate & unmount connectors: apply a voltage of 500 VDC between adjacent terminals and between terminals to ground.	1000 Megohms MINIMUM
<b>Dielectric Withstanding Voltage</b>	Unmate connectors: apply a voltage of {two times the rated voltage plus 1000 volts} VAC for 1 minute between adjacent terminals and between terminals to ground.	No breakdown; current leakage < 5 mA
<b>Capacitance</b>	Measure between adjacent terminals at 1 MHz.	2 picofarads MAXIMUM
<b>Temperature Rise (via Current Cycling)</b>	Mate connectors: measure the temperature rise at the rated current after: 1) 96 hours (steady state) 2) 240 hours (45 minutes ON and 15 minutes OFF per hour) 3) 96 hours (steady state)	Temperature rise: +30°C MAXIMUM

REVISION: <b>N</b>	ECR/ECN INFORMATION: EC No: <b>UCP2018-0645</b> DATE: <b>2017/10/27</b>	TITLE: <b>PRODUCT SPECIFICATION MICRO-FIT SINGLE ROW CONNECTORS</b>	SHEET No. <b>4 of 9</b>
DOCUMENT NUMBER: <b>PS-43650</b>	CREATED / REVISED BY: <b>SSOUSEK</b>	CHECKED BY: <b>JBELL</b>	APPROVED BY: <b>FSMITH</b>



# PRODUCT SPECIFICATION

## 5.2 MECHANICAL REQUIREMENTS

DESCRIPTION	TEST CONDITION	REQUIREMENT
<b>Connector Mate and Unmate Forces</b>	Mate and unmate connector (male to female) at a rate of 25 ± 6 mm (1 ± ¼ inch) per minute. (per circuit)	8.0 N (1.8 lbf) MAXIMUM insertion force & 2.4 N (0.5 lbf) MINIMUM withdrawal force
<b>Crimp Terminal Retention Force (in Housing)</b>	Axial pullout force on the terminal in the housing at a rate of 25 ± 6 mm (1 ± ¼ inch) per minute.	24.5 N (5.5 lbf) MINIMUM retention force
<b>Crimp Terminal Insertion Force (into Housing)</b>	Apply an axial insertion force on the terminal at a rate of 25 ± 6 mm (1 ± ¼ inch) per minute.	14.7 N (3.3 lbf) MAXIMUM insertion force
<b>Durability</b>	Mate connectors up to 30 cycles at a maximum rate of 10 cycles per minute	20 milliohms MAXIMUM (change from initial)
<b>Vibration (Random)</b>	Mate connectors and vibrate per EIA 364-28, test condition VII, Letter D. Test Duration: 15 minutes each axis.	20 milliohms MAXIMUM (change from initial) & Discontinuity < 1 microsecond
<b>Shock (Mechanical)</b>	Mate connectors and shock at 50 g's with ½ sine wave (11 milliseconds) shocks in the ±X,±Y,±Z axes (18 shocks total). (Per EIA-364-27, Test Condition H)	20 milliohms MAXIMUM (change from initial) & Discontinuity < 1 microsecond
<b>Wire Pullout Force (Axial)</b>	Apply an axial pullout force on the wire at a rate of 25 ± 6 mm (1 ± ¼ inch) per minute.	MINIMUM pullout force 18 awg: 89.0 N (20.0 lbf) 0.75 mm2: 89.0 N (20.0 lbf) 20 awg: 57.8 N (13.0 lbf) 22 awg: 35.6 N (8.0 lbf) 24 awg: 22.2 N (5.0 lbf) 26 awg: 13.3 N (3.0 lbf) 28 awg: 8.9 N (2.0 lbf) 30 awg: 6.6 N (1.5 lbf)  Values may vary depending on crimp tooling. Refer to Molex Applicator Tooling Specification.
<b>Normal Force</b>	Apply a perpendicular force.	2.7 N (0.6 lbf) MINIMUM
<b>Pin to Header Retention</b>	Apply axial push force to pin at a rate of 25 ± 6 mm (1 ± ¼ inch) per minute.	13.7 N (3.1 lbf) MINIMUM pushout force
<b>Thumb Latch to Ramp Yield Strength</b>	Full mate and then Unmate the connectors at a rate of 25 ± 6 mm (1 ± ¼ inch) per minute.	68.4 N (15.4 lbf) MINIMUM Yield Strength

REVISION:	ECR/ECN INFORMATION:	TITLE:	SHEET No.
<b>N</b>	EC No: <b>UCP2018-0645</b> DATE: <b>2017/10/27</b>	<b>PRODUCT SPECIFICATION MICRO-FIT SINGLE ROW CONNECTORS</b>	<b>5 of 9</b>
DOCUMENT NUMBER:	CREATED / REVISED BY:	CHECKED BY:	APPROVED BY:
<b>PS-43650</b>	<b>SSOUSEK</b>	<b>JBELL</b>	<b>FSMITH</b>



# PRODUCT SPECIFICATION

## 5.3 ENVIRONMENTAL REQUIREMENTS

DESCRIPTION	TEST CONDITION	REQUIREMENT
<b>Thermal Aging</b>	Mate connectors; expose to: 240 hours at 105 ± 2°C OR 500 hours at 85 ± 2°C	20 milliohms MAXIMUM (change from initial)
<b>Humidity (Steady State)</b>	Mate connectors: expose to a temperature of 40 ± 2°C with a relative humidity of 90-95% for 96 hours.  Note: Remove surface moisture and air dry for 1 hour prior to measurements.	20 milliohms MAXIMUM (change from initial) & Dielectric Withstanding Voltage: No Breakdown at 500 VAC & Insulation Resistance: 1000 Megohms MINIMUM
<b>Solderability</b>	Per SMES-152	Solder coverage: 95% MINIMUM (per SMES-152)
<b>Solder Resistance</b>	<b>A) Wave Solder Process</b> Dip connector terminal tails in solder; Solder Duration: 10 seconds MAX Solder Temperature: 260°C MAX Per AS-40000-5013  <b>B) Convection Reflow Solder Process</b> 260°C MAX Per AS-40000-5013	Visual: No Damage to insulator material
<b>Salt Spray</b>	Mate connectors Orientation: Horizontal, latch on top surface Duration: 48 hours exposure Atmosphere: Salt spray from a 5% solution Temperature: 35 ± 2°C	20 milliohms MAXIMUM (change from initial)
<b>Cold Resistance</b>	Mate connectors: Duration: 96 hours; Temperature: -40 ± 3°C	20 milliohms MAXIMUM (change from initial)

## 6.0 PACKAGING

Parts shall be packaged to protect against damage during handling, transit and storage per the packaging specifications listed below:

Receptacle, TPA Receptacle and Plug: Bulk Packaged

Headers: PK-70873-0321, PK-70873-0811, PK-70873-07\*\*

REVISION: <b>N</b>	ECR/ECN INFORMATION: EC No: <b>UCP2018-0645</b> DATE: <b>2017/10/27</b>	TITLE: <b>PRODUCT SPECIFICATION MICRO-FIT SINGLE ROW CONNECTORS</b>	SHEET No. <b>6 of 9</b>
DOCUMENT NUMBER: <b>PS-43650</b>	CREATED / REVISED BY: <b>SSOUSEK</b>	CHECKED BY: <b>JBELL</b>	APPROVED BY: <b>FSMITH</b>



# PRODUCT SPECIFICATION

## 7.0 GAGES AND FIXTURES

It is recommended that test plugs (Series 44242) be used for continuity testing of receptacles. Standard mating parts should not be used for harness testing.

NOTE: The use of unauthorized testing devices and/or probes with a Molex product may cause damage to and affect functionality of the Molex product, and such use may void any and all warranties, expressed or implied.

## 8.0 OTHER INFORMATION

### 8.1 CABLE TIE AND OR WIRE TWIST LOCATION

CKT Sizes	Dim T	Min.
2-4	.500	(12.70)
5-8	.750	(19.10)
9-12	1.000	(25.40)

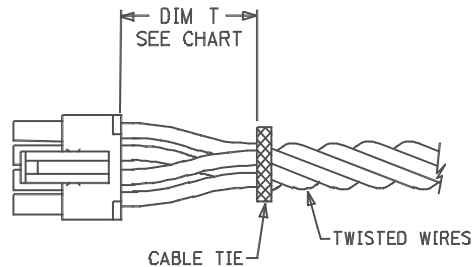

The "T" dimension defines a "free" length of wire, or a length of wire that is not subject to significant bias by external factors such as a wire tie, wire twisting, or other means of bending or deforming of the wires that repositions them from their natural relaxed state or location where they enter the housing. Wires are to be dressed in such a manner to allow the terminals to float freely in the pocket.

### 8.2 CONTACT ENGAGEMENT (WIPE) FOR FULLY MATED NOMINAL COMPONENTS (FOR REFERENCE ONLY)

Receptacle	Mated to Plug/ Header	Application	Contact Wipe (nominal)
43645 Receptacle <sup>(1)</sup>	43640 Plug	Wire-to-Wire	0.083 in/(2.11 mm)
	43650 Header	Wire-to-Board	0.069 in/(1.75mm)
171850 TPA Receptacle <sup>(1)</sup>	43640 Plug	Wire-to-Wire	0.072 in/(1.84mm)
	43650 Header	Wire-to-Board	0.063 in/(1.60mm)
	200875 TPA Plug	Wire-to-Wire	0.068 in/(1.72mm)

**Note (1):** Contact Wipe is based on 43030 female crimp terminal. If using 46235 female crimp terminal, reduce Contact Wipe by .005 in/(0.13 mm).

REVISION: <b>N</b>	ECR/ECN INFORMATION: EC No: <b>UCP2018-0645</b> DATE: <b>2017/10/27</b>	TITLE: <b>PRODUCT SPECIFICATION MICRO-FIT SINGLE ROW CONNECTORS</b>	SHEET No. <b>7 of 9</b>
DOCUMENT NUMBER: <b>PS-43650</b>	CREATED / REVISED BY: <b>SSOUSEK</b>	CHECKED BY: <b>JBELL</b>	APPROVED BY: <b>FSMITH</b>





# PRODUCT SPECIFICATION

## 8.3 STANDARD POLARIZATION FOR HEADERS AND PLUGS (HEADERS ARE SHOWN)

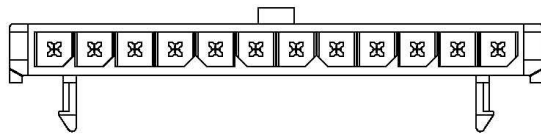

12-CKT.

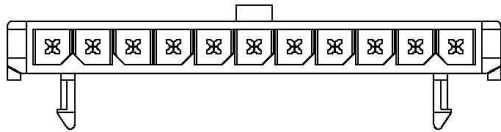

11-CKT.

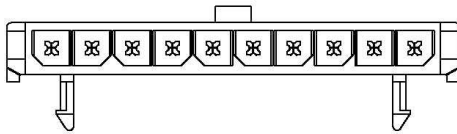

10-CKT.

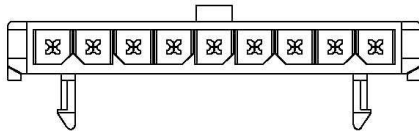

9-CKT.

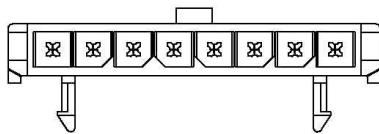

8-CKT.

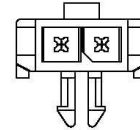

2-CKT.

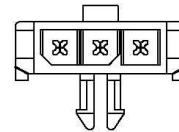

3-CKT.

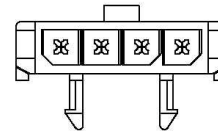

4-CKT.

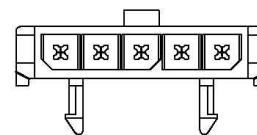

5-CKT.

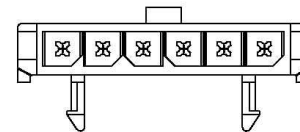

6-CKT.

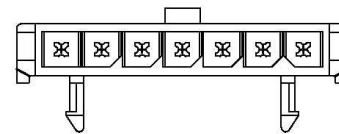

7-CKT.

REVISION: <b>N</b>	ECR/ECN INFORMATION: EC No: <b>UCP2018-0645</b> DATE: <b>2017/10/27</b>	TITLE: <b>PRODUCT SPECIFICATION MICRO-FIT SINGLE ROW CONNECTORS</b>	SHEET No. <b>8 of 9</b>
DOCUMENT NUMBER: <b>PS-43650</b>	CREATED / REVISED BY: <b>SSOUSEK</b>	CHECKED BY: <b>JBELL</b>	APPROVED BY: <b>FSMITH</b>



# PRODUCT SPECIFICATION

## 8.4 STANDARD POLARIZATION FOR RECEPTACLES

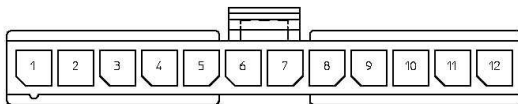

12-CKT.

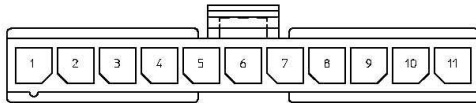

11-CKT.

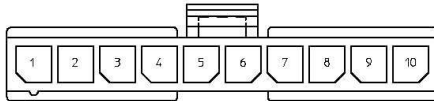

10-CKT.

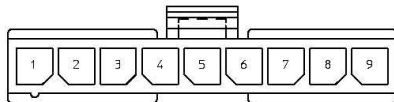

9-CKT.

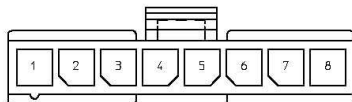

8-CKT.

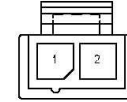

2-CKT.

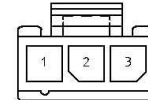

3-CKT.

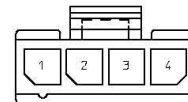

4-CKT.

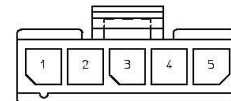

5-CKT.

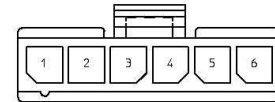

6-CKT.

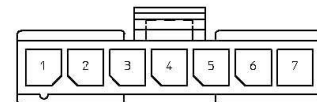

7-CKT.

REVISION: <b>N</b>	ECR/ECN INFORMATION: EC No: <b>UCP2018-0645</b> DATE: <b>2017/10/27</b>	TITLE: <b>PRODUCT SPECIFICATION MICRO-FIT SINGLE ROW CONNECTORS</b>	SHEET No. <b>9 of 9</b>
DOCUMENT NUMBER: <b>PS-43650</b>	CREATED / REVISED BY: <b>SSOUSEK</b>	CHECKED BY: <b>JBELL</b>	APPROVED BY: <b>FSMITH</b>

CKT SIZE	PARTS PER CHANNEL	PARTS PER TRAY	PARTS PER CARTON (SPQ)
2	32	192	3264
3	25	150	2550
4	20	120	2040
5	17	102	1734
6	15	90	1530
7	13	78	1326
8	11	66	1122
9	10	60	1020
10	9	54	918
11	8	48	816
12	8	48	816

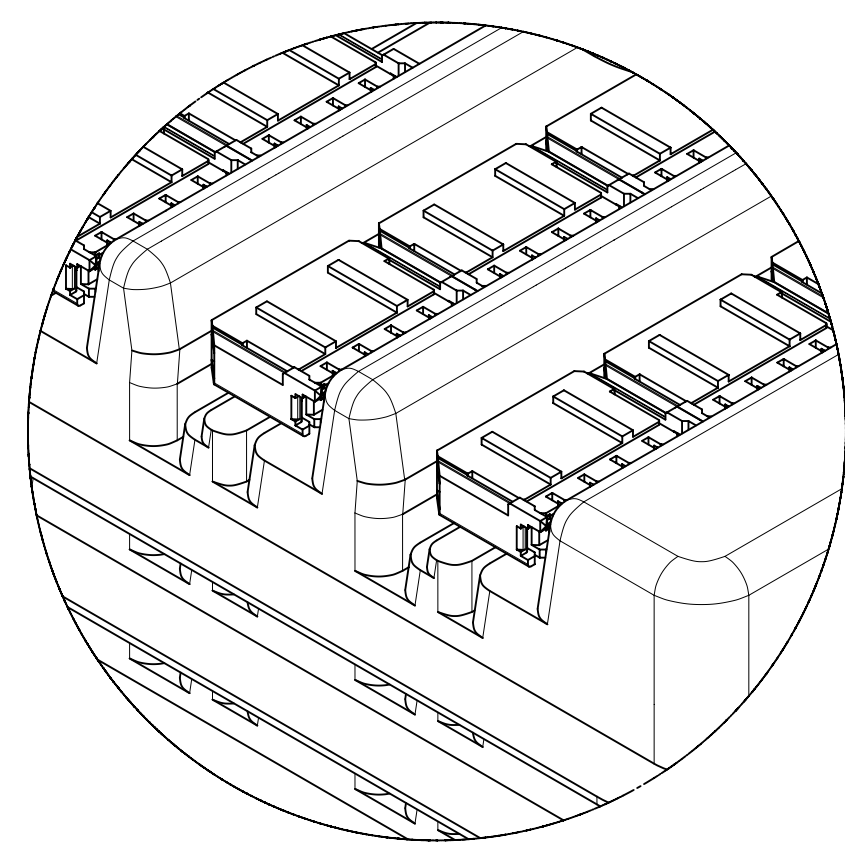
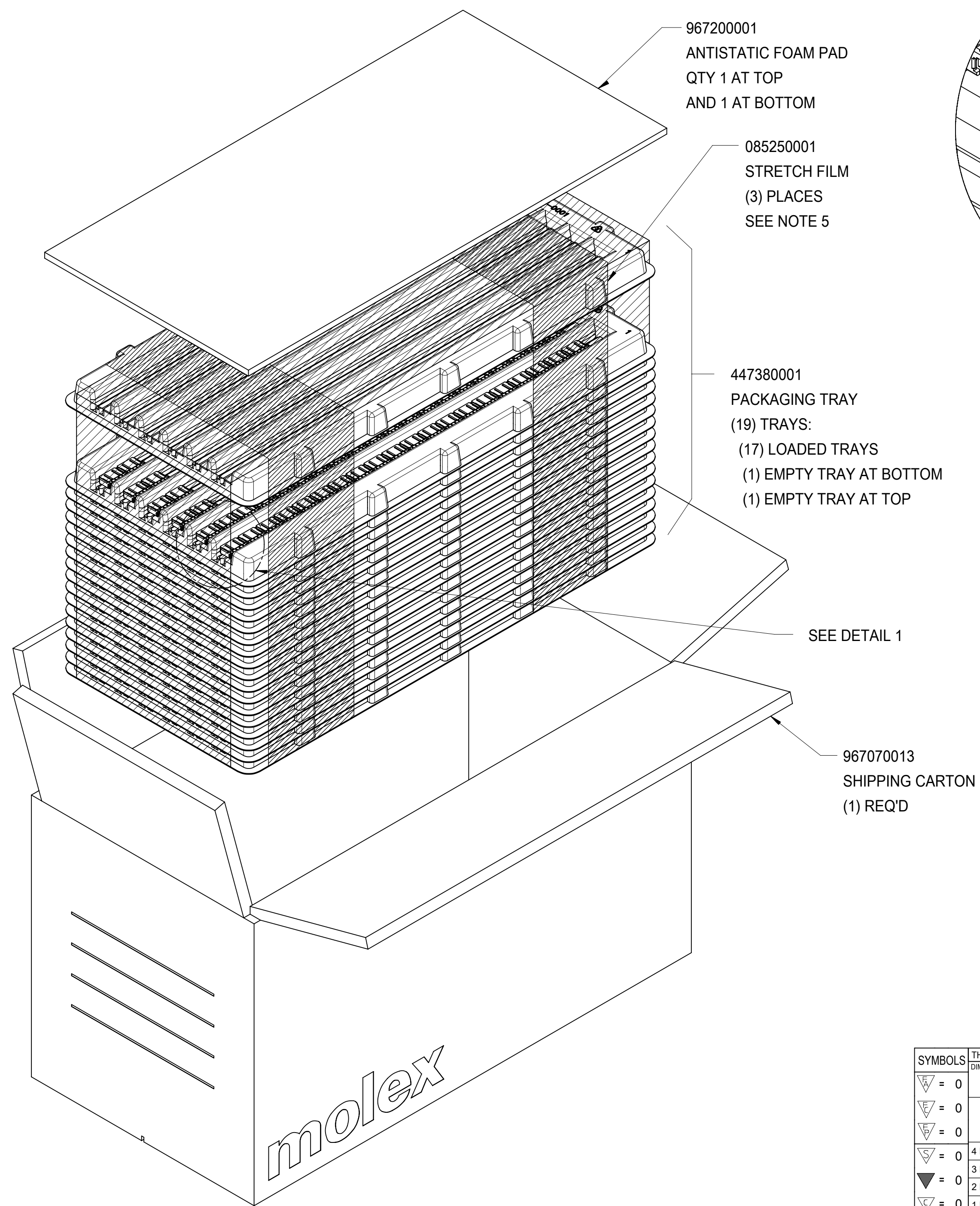

DETAIL 1

- PACKAGING INSTRUCTIONS:**
1. PRIMARY SHIPPING CARTON TO BE P/N SPECIFIED HAVING A 275 POUND BURST RATING. PREPARE CARTONS BY SEALING BOTTOM FLAPS WITH 2-INCH WIDE CLEAR ADHESIVE TAPE EXTENDING 2 INCHES MINIMUM UP EACH END OF CARTON.
  2. LOAD HEADERS INTO TRAY CHANNELS WITH PINS IN ORIENTATION SHOWN IN DETAIL 1.
  3. TRAYS TO BE LOADED PER QUANTITIES SPECIFIED IN CHART. 17 TRAYS TO BE FULLY LOADED. BOTTOM AND TOP TRAYS ARE EMPTY.
  4. TRAYS TO BE STACKED IN THE SAME ORIENTATION.
  5. STACKED TRAYS TO BE BUNDLED WITH 5-INCH WIDE STRETCH FILM WRAPPED 3 TIMES LENGTH WISE OF TRAYS TO COVER ENTIRE OPEN END OF TRAY CHANNELS, AND WRAPPED 3 TIMES AROUND EACH END OF STACK, AS SHOWN. SEQUENCE OF WRAPS MAY VARY.
  6. BUNDLED TRAYS TO BE INSERTED INTO CARTON.
  7. ANTISTAT FOAM PADS TO BE ADDED ON TOP OF TRAY BUNDLE AS REQUIRED TO FILL CARTON. NOTE: QUANTITY OF FOAM FILLER PADS USED SHOULD BE ENOUGH TO FILL CARTON BUT NOT CAUSE TOP OF CARTON TO BULGE WHEN FLAPS ARE CLOSED.
  8. CLOSE AND SEAL LONG FLAPS OF CARTON WITH 2-INCH WIDE ADHESIVE TAPE THAT SHOULD EXTEND A MINIMUM OF 2 INCHES DOWN SIDE OF CARTON.
  9. APPLY APPROPRIATE LABELS FOR PRODUCT ID, SHIPPING AND SAFETY AGENCY.

<b>SYMBOLS</b> THIS DRAWING CONTAINS INFORMATION THAT IS PROPRIETARY TO MOLEX ELECTRONIC TECHNOLOGIES, LLC AND SHOULD NOT BE USED WITHOUT WRITTEN PERMISSION DIMENSION UNITS: MM, NTS SCALE: NTS CURRENT REV DESC: ADD BOT. TRAY / WRAP	GENERAL TOLERANCES (UNLESS SPECIFIED) 4 PLACES ± 3 PLACES ± 2 PLACES ± 1 PLACE ± 0 PLACES ± ANGULAR TOL ± °		EC NO: 618632 DRWN: MPETROVICH 2018/07/26 CHK'D: SSOUSEK 2019/06/11 APPR: FSMITH 2019/06/11 INITIAL REVISION: DRWN: RFC_PLMIMP 2017/11/10 APPR: REDGLEW 2001/03/12				
	DRAFT WHERE APPLICABLE MUST REMAIN WITHIN DIMENSIONS		THIRD ANGLE PROJECTION 				
DOCUMENT STATUS: P1 RELEASE DATE: 2019/06/11 20:34:16		MICRO-FIT (3.0) SINGLE ROW VERTICAL HEADER PACKAGING SPECIFICATION		PACKAGING DESIGN DRAWING			
DOCUMENT NUMBER: PK-70873-0811		DOC TYPE: PDD DOC PART: 001 REVISION: J		MATERIAL NUMBER: NA CUSTOMER: GENERAL MARKET SHEET NUMBER: 1 OF 1			

## Micro-Fit (3.0) Connector System (Wire to Wire & Wire to Board)

### 1.0 SCOPE

This Test Specification covers the 3.00 mm (.118 inch) centerline (pitch) connector series terminated with 20-30 AWG wire using crimp technology.

### 2.0 PRODUCT DESCRIPTION

#### 2.1 PRODUCT NAME, SERIES, AND PART NUMBER(S)

- Micro-Fit (3.0) Receptacle Series : 43025, 43645, 44133 (BMI)
- Micro-Fit (3.0) Plug Series : 43020, 43640, 44300 (BMI)
- Micro-Fit (3.0) Right Angle & Vertical Header Series : 43045, 43650, 44067
- Micro-Fit (3.0) Compliant Pin Vertical Header Series : 44914
- Micro-Fit (3.0) Female Crimp Terminal Series : 43030
- Micro-Fit (3.0) Male Crimp Terminal Series : 43031
- Micro-Fit (3.0) Female Crimp Terminal with Lubricant : 45773

#### 2.1.1 SERIES NUMBERS TESTED

- Micro-Fit (3.0) Receptacle : 43025
- Micro-Fit (3.0) Plug : 43020
- Micro-Fit (3.0) Right Angle & Vertical Headers : 43045
- Micro-Fit (3.0) Female Crimp Terminal : 43030
- Micro-Fit (3.0) Male Crimp Terminal : 43031

#### 2.2 DIMENSIONS, MATERIALS, PLATINGS AND MARKINGS

See the appropriate sales drawings for information on dimensions, materials, plating, and markings.

#### 2.3 PRODUCT SPECIFICATION TITLE AND DOCUMENT NUMBER

- Product Specification Micro-Fit Dual Row Connectors  
Document Number: PS-43045
- Product Specification Micro-Fit Single Row Connectors  
Document Number: PS-43650
- Product Specification Micro-Fit (3.0) BMI Floating Connector System  
Document Number: PS-44300-001

### 3.0 APPLICABLE DOCUMENTS AND SPECIFICATIONS

#### 3.1 TESTING PROCEDURES AND SEQUENCES

EIA-364-1000.01

<u>REVISION:</u> <b>A2</b>	<u>ECR/ECN INFORMATION:</u> EC No: <b>109530</b> DATE: <b>2016 / 10 /18</b>	<u>TITLE:</u> <b>TEST SUMMARY MICRO-FIT (3.0) CONNECTORS</b>	<u>SHEET No.</u> <b>1 of 10</b>
<u>DOCUMENT NUMBER:</u> <b>TS-43045-001</b>		<u>CREATED / REVISED BY:</u> <b>JDFOX</b>	<u>CHECKED BY:</u> <b>SSOUSEK</b>
		<u>APPROVED BY:</u> <b>FSMITH</b>	

### 3.2 OTHER DOCUMENTS AND SPECIFICATIONS

None

### 4.0 QUALIFICATION

Laboratory conditions and sample selection are in accordance with **EIA-364**.

### 5.0 PERFORMANCE RESULTS

#### 5.1 ELECTRICAL PERFORMANCE RESULTS

##### WIRE TO WIRE CONFIGURATION

ITEM	DESCRIPTION	TREATMENT	REQUIREMENT	MEAN	MINIMUM	MAXIMUM
<b>1A</b>	CONTACT RESISTANCE (LOW LEVEL)	Initial **	10 milliohms MAXIMUM	19.95 mΩ	19.74 mΩ	20.40 mΩ
		After Durability Δ mΩ	20 milliohms MAXIMUM	-0.23 mΩ	-0.03 mΩ	0.67 mΩ
		After Temperature Life Δ mΩ	20 milliohms MAXIMUM	0.38 mΩ	0.08 mΩ	1.01 mΩ
		After Reseating Δ mΩ	20 milliohms MAXIMUM	0.25 mΩ	-0.53 mΩ	1.32 mΩ

NOTE : \*\* APPROXIMATELY 16.6 mΩ OF THE MEASUREMENT VALUE IS ATTRIBUTED TO THE BULK RESISTANCE OF THE 13 INCHES OF WIRE USED IN SAMPLE PREPARATION.

##### WIRE TO BOARD CONFIGURATION

ITEM	DESCRIPTION	TREATMENT	REQUIREMENT	MEAN	MINIMUM	MAXIMUM
<b>1B</b>	CONTACT RESISTANCE (LOW LEVEL)	Initial	10 milliohms MAXIMUM	4.75 mΩ	4.55 mΩ	4.98 mΩ
		After Durability Δ mΩ	20 milliohms MAXIMUM	-0.23 mΩ	-0.03 mΩ	0.67 mΩ
		After Temperature Life Δ mΩ	20 milliohms MAXIMUM	0.38 mΩ	0.08 mΩ	1.01 mΩ
		After Reseating Δ mΩ	20 milliohms MAXIMUM	0.25 mΩ	-0.53 mΩ	1.32 mΩ

NOTE : SEE APPENDIX "A" FOR TEST SEQUENCE DESCRIPTION.

REVISION: <b>A2</b>	ECR/ECN INFORMATION: EC No: 109530 DATE: 2016 / 10 /18	TITLE: <b>TEST SUMMARY MICRO-FIT (3.0) CONNECTORS</b>	SHEET No. <b>2 of 10</b>
DOCUMENT NUMBER: <b>TS-43045-001</b>	CREATED / REVISED BY: <b>JDFOX</b>	CHECKED BY: <b>SSOUSEK</b>	APPROVED BY: <b>FSMITH</b>

## 5.1 ELECTRICAL PERFORMANCE RESULTS (continued)

### WIRE TO WIRE CONFIGURATION

ITEM	DESCRIPTION	TREATMENT	REQUIREMENT	MEAN	MINIMUM	MAXIMUM
<b>2A</b>	Contact Resistance (Low Level)	Initial **	10 milliohms MAXIMUM	<b>20.01 mΩ</b>	<b>19.59 mΩ</b>	<b>23.29 mΩ</b>
		After Durability Δ mΩ	20 milliohms MAXIMUM	<b>0.19 mΩ</b>	<b>-0.02 mΩ</b>	<b>0.64 mΩ</b>
		After Thermal Shock Δ mΩ	20 milliohms MAXIMUM	<b>0.34 mΩ</b>	<b>0.08 mΩ</b>	<b>0.74 mΩ</b>
		After Cyclic Humidity Δ mΩ	20 milliohms MAXIMUM	<b>0.62 mΩ</b>	<b>0.14 mΩ</b>	<b>1.77 mΩ</b>
		After Reseating Δ mΩ	20 milliohms MAXIMUM	<b>0.61 mΩ</b>	<b>0.11 mΩ</b>	<b>3.09 mΩ</b>

NOTE : \*\* APPROXIMATELY 16.6 mΩ OF THE MEASUREMENT VALUE IS ATTRIBUTED TO THE BULK RESISTANCE OF THE 13 INCHES OF WIRE USED IN SAMPLE PREPARATION.

### WIRE TO BOARD CONFIGURATION

ITEM	DESCRIPTION	TREATMENT	REQUIREMENT	MEAN	MINIMUM	MAXIMUM
<b>2B</b>	Contact Resistance (Low Level)	Initial	10 milliohms MAXIMUM	<b>4.75 mΩ</b>	<b>4.55 mΩ</b>	<b>4.98 mΩ</b>
		After Durability Δ mΩ	20 milliohms MAXIMUM	<b>0.42 mΩ</b>	<b>-0.02 mΩ</b>	<b>2.03 mΩ</b>
		After Thermal Shock Δ mΩ	20 milliohms MAXIMUM	<b>1.56 mΩ</b>	<b>0.25 mΩ</b>	<b>5.71 mΩ</b>
		After Cyclic Humidity Δ mΩ	20 milliohms MAXIMUM	<b>1.28 mΩ</b>	<b>0.15 mΩ</b>	<b>4.60 mΩ</b>
		After Reseating Δ mΩ	20 milliohms MAXIMUM	<b>2.19 mΩ</b>	<b>0.23 mΩ</b>	<b>8.04 mΩ</b>

NOTE : SEE APPENDIX "A" FOR TEST SEQUENCE DESCRIPTION

REVISION: <b>A2</b>	ECR/ECN INFORMATION: EC No: <b>109530</b> DATE: <b>2016 / 10 /18</b>	TITLE: <b>TEST SUMMARY MICRO-FIT (3.0) CONNECTORS</b>	SHEET No. <b>3 of 10</b>
DOCUMENT NUMBER: <b>TS-43045-001</b>	CREATED / REVISED BY: <b>JDFOX</b>	CHECKED BY: <b>SSOUSEK</b>	APPROVED BY: <b>FSMITH</b>

## 5.1 ELECTRICAL PERFORMANCE RESULTS (continued)

### WIRE TO BOARD CONFIGURATION – 2 CIRCUIT VERSION

ITEM	DESCRIPTION	TREATMENT	REQUIREMENT	MEAN	MINIMUM	MAXIMUM
3A	Contact Resistance (Low Level)	Initial **	10 milliohms MAXIMUM	10.26 mΩ	10.17 mΩ	10.46 mΩ
		After Durability Δ mΩ	20 milliohms MAXIMUM	0.75 mΩ	0.16 mΩ	1.57 mΩ
		After Temperature Life Pre-Conditioned Δ mΩ	20 milliohms MAXIMUM	1.88 mΩ	0.58 mΩ	3.77 mΩ
		After Vibration Δ mΩ	20 milliohms MAXIMUM	1.28 mΩ	0.15 mΩ	4.60 mΩ
		No Discontinuity	Discontinuity < 1 microsecond			

NOTE : \*\* APPROXIMATELY 7.8 mΩ OF THE MEASUREMENT VALUE IS ATTRIBUTED TO THE BULK RESISTANCE OF THE 6 INCHES OF WIRE USED IN SAMPLE PREPARATION.

### WIRE TO BOARD CONFIGURATION –12 CIRCUIT VERSION

ITEM	DESCRIPTION	TREATMENT	REQUIREMENT	MEAN	MINIMUM	MAXIMUM
3B	Contact Resistance (Low Level)	Initial **	10 milliohms MAXIMUM	10.24 mΩ	9.85 mΩ	10.52 mΩ
		After Durability Δ mΩ	20 milliohms MAXIMUM	0.41 mΩ	0.14 mΩ	2.13 mΩ
		After Temperature Life Pre-Conditioned Δ mΩ	20 milliohms MAXIMUM	0.81 mΩ	0.16 mΩ	3.68 mΩ
		After Vibration Δ mΩ	20 milliohms MAXIMUM	1.14 mΩ	0.25 mΩ	3.56 mΩ
		No Discontinuity	Discontinuity < 1 microsecond			

NOTES : \*\* APPROXIMATELY 7.8 mΩ OF THE MEASUREMENT VALUE IS ATTRIBUTED TO THE BULK RESISTANCE OF THE 6 INCHES OF WIRE USED IN SAMPLE PREPARATION.

SEE APPENDIX "A" FOR TEST SEQUENCE DESCRIPTION

REVISION: <b>A2</b>	ECR/ECN INFORMATION: EC No: 109530 DATE: 2016 / 10 /18	TITLE: <b>TEST SUMMARY MICRO-FIT (3.0) CONNECTORS</b>	SHEET No. <b>4 of 10</b>
DOCUMENT NUMBER: <b>TS-43045-001</b>	CREATED / REVISED BY: <b>JDFOX</b>	CHECKED BY: <b>SSOUSEK</b>	APPROVED BY: <b>FSMITH</b>

## 5.1 ELECTRICAL PERFORMANCE RESULTS (continued)

### WIRE TO WIRE CONFIGURATION

ITEM	DESCRIPTION	TREATMENT	REQUIREMENT	MEAN	MINIMUM	MAXIMUM
4A	Contact Resistance (Low Level)	Initial **	10 milliohms MAXIMUM	20.07 mΩ	19.95 mΩ	20.50 mΩ
		After Durability Δ mΩ	20 milliohms MAXIMUM	0.31 mΩ	-0.02 mΩ	0.72 mΩ
		After Temperature Life Pre-Conditioned Δ mΩ	20 milliohms MAXIMUM	0.34 mΩ	0.07 mΩ	0.97 mΩ
		Thermal Cycling 167 Hours Δ mΩ	20 milliohms MAXIMUM	0.42 mΩ	0.10 mΩ	2.01 mΩ
		Thermal Cycling 334 Hours Δ mΩ	20 milliohms MAXIMUM	0.41 mΩ	-0.06 mΩ	1.03 mΩ
		Thermal Cycling 500 Hours Δ mΩ	20 milliohms MAXIMUM	0.64 mΩ	0.03 mΩ	2.79 mΩ
		After Reseating Δ mΩ	20 milliohms MAXIMUM	0.54 mΩ	0.14 mΩ	2.45 mΩ

NOTES : \*\* APPROXIMATELY 16.6 mΩ OF THE MEASUREMENT VALUE IS ATTRIBUTED TO THE BULK RESISTANCE OF THE 13 INCHES OF WIRE USED IN SAMPLE PREPARATION.

SEE APPENDIX "A" FOR TEST SEQUENCE DESCRIPTION

REVISION: <b>A2</b>	ECR/ECN INFORMATION: EC No: 109530 DATE: 2016 / 10 /18	TITLE: <b>TEST SUMMARY MICRO-FIT (3.0) CONNECTORS</b>	SHEET No. <b>5 of 10</b>
DOCUMENT NUMBER: <b>TS-43045-001</b>	CREATED / REVISED BY: <b>JDFOX</b>	CHECKED BY: <b>SSOUSEK</b>	APPROVED BY: <b>FSMITH</b>



## 5.1 ELECTRICAL PERFORMANCE RESULTS (continued)

### WIRE TO BOARD CONFIGURATION

ITEM	DESCRIPTION	TREATMENT	REQUIREMENT	MEAN	MINIMUM	MAXIMUM
<b>4B</b>	Contact Resistance (Low Level)	Initial	10 milliohms MAXIMUM	<b>4.78 mΩ</b>	<b>4.56 mΩ</b>	<b>5.53 mΩ</b>
		After Durability Δ mΩ	20 milliohms MAXIMUM	<b>0.48 mΩ</b>	<b>0.06 mΩ</b>	<b>2.35 mΩ</b>
		After Temperature Life Pre-Conditioned Δ mΩ	20 milliohms MAXIMUM	<b>1.07 mΩ</b>	<b>0.13 mΩ</b>	<b>5.80 mΩ</b>
		Thermal Cycling 167 Hours Δ mΩ	20 milliohms MAXIMUM	<b>1.38 mΩ</b>	<b>0.30 mΩ</b>	<b>4.68 mΩ</b>
		Thermal Cycling 334 Hours Δ mΩ	20 milliohms MAXIMUM	<b>1.63 mΩ</b>	<b>0.31 mΩ</b>	<b>5.17 mΩ</b>
		Thermal Cycling 500 Hours Δ mΩ	20 milliohms MAXIMUM	<b>3.04 mΩ</b>	<b>0.69 mΩ</b>	<b>8.51 mΩ</b>
		After Reseating Δ mΩ	20 milliohms MAXIMUM	<b>3.48 mΩ</b>	<b>0.41 mΩ</b>	<b>8.94 mΩ</b>

NOTE : SEE APPENDIX "A" FOR TEST SEQUENCE DESCRIPTION

REVISION: <b>A2</b>	ECR/ECN INFORMATION: EC No: <b>109530</b> DATE: <b>2016 / 10 /18</b>	TITLE: <b>TEST SUMMARY MICRO-FIT (3.0) CONNECTORS</b>	SHEET No. <b>6 of 10</b>
DOCUMENT NUMBER: <b>TS-43045-001</b>	CREATED / REVISED BY: <b>JDFOX</b>	CHECKED BY: <b>SSOUSEK</b>	APPROVED BY: <b>FSMITH</b>

## 5.1 ELECTRICAL PERFORMANCE RESULTS (continued)

ITEM	DESCRIPTION	WIRE GAUGE	REQUIREMENT	AMPERAGE
5	Temperature Rise & Current Cycling	30 AWG	30°C Max. Temp. Rise	2.5 Amps
		26 AWG	30°C Max. Temp. Rise	3.0 Amps
		24 AWG	30°C Max. Temp. Rise	4.0 Amps
		20 AWG	30°C Max. Temp. Rise	5.5 Amps

## 5.2 MECHANICAL PERFORMANCE RESULTS

ITEM	DESCRIPTION	Wire Gauge	REQUIREMENT	MEAN	MINIMUM	MAXIMUM
6	Wire Pullout Force (Newtons)	20 AWG	57.8 N Minimum	127.4	117.5	134.7
		22 AWG	35.6 N Minimum	86.1	80.2	90.4
		24 AWG	22.2 N Minimum	53.6	44.7	58.08
		26 AWG	13.3 N Minimum	36.1	33.8	38.3
		28 AWG	8.9 N Minimum	21.1	18.1	23.2
		30 AWG	6.6 N Minimum	18.2	13.5	24.6

ITEM	DESCRIPTION	REQUIREMENT	MEAN	MINIMUM	MAXIMUM
7	Contact Normal Force (grams)	275 g Min	331 g	322 g	343 g

REVISION: <b>A2</b>	ECR/ECN INFORMATION: EC No: 109530 DATE: 2016 / 10 /18	TITLE: <b>TEST SUMMARY MICRO-FIT (3.0) CONNECTORS</b>	SHEET No. <b>7 of 10</b>
DOCUMENT NUMBER: <b>TS-43045-001</b>	CREATED / REVISED BY: <b>JDFOX</b>	CHECKED BY: <b>SSOUSEK</b>	APPROVED BY: <b>FSMITH</b>

**APPENDIX A**  
TEST SEQUENCES

<b>REVISION:</b> <b>A2</b>	<b>ECR/ECN INFORMATION:</b> EC No: <b>109530</b> DATE: <b>2016 / 10 /18</b>	<b>TITLE:</b> <b>TEST SUMMARY MICRO-FIT (3.0) CONNECTORS</b>	<b>SHEET No.</b> <b>8 of 10</b>
<b>DOCUMENT NUMBER:</b> <b>TS-43045-001</b>	<b>CREATED / REVISED BY:</b> <b>JDFOX</b>	<b>CHECKED BY:</b> <b>SSOUSEK</b>	<b>APPROVED BY:</b> <b>FSMITH</b>

## A.1 TEST SEQUENCES

### SEQUENCE 1 1A Wire to Wire 1B Wire to Board

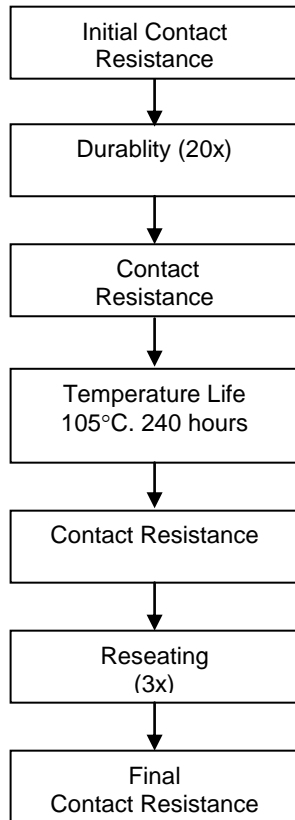

### SEQUENCE 2 2A Wire to Wire 2B Wire to Board

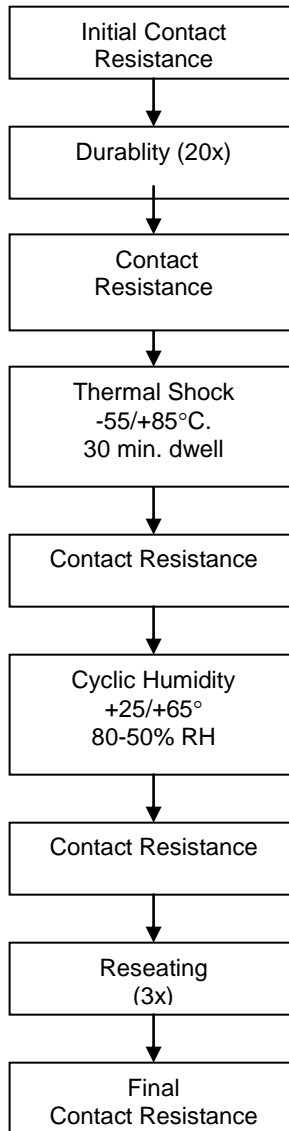

REVISION: <b>A2</b>	ECR/ECN INFORMATION: EC No: <b>109530</b> DATE: <b>2016 / 10 /18</b>	TITLE: <b>TEST SUMMARY MICRO-FIT (3.0) CONNECTORS</b>	SHEET No. <b>9 of 10</b>
DOCUMENT NUMBER: <b>TS-43045-001</b>	CREATED / REVISED BY: <b>JDFOX</b>	CHECKED BY: <b>SSOUSEK</b>	APPROVED BY: <b>FSMITH</b>

## A.1 TEST SEQUENCES (continued)

### SEQUENCE 3 3A Wire to Wire 3B Wire to Board

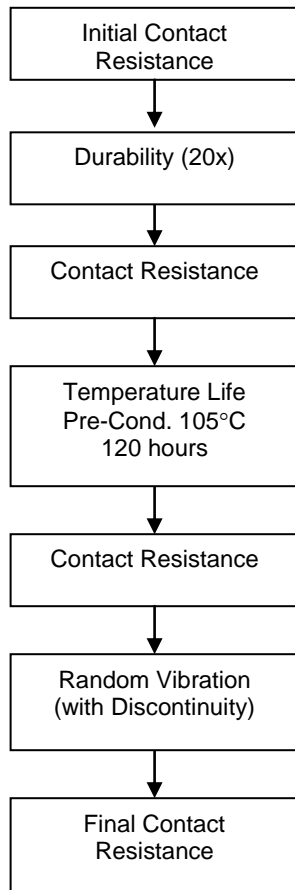

### SEQUENCE 4 4A Wire to Wire 4B Wire to Board

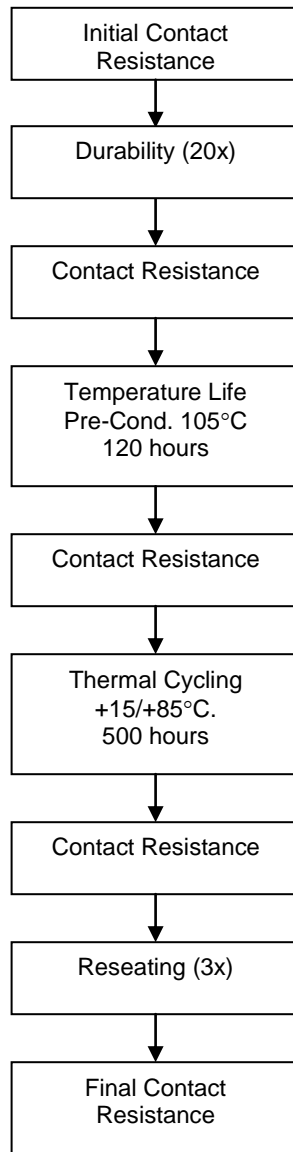

REVISION: <b>A2</b>	ECR/ECN INFORMATION: EC No: <b>109530</b> DATE: <b>2016 / 10 /18</b>	TITLE: <b>TEST SUMMARY MICRO-FIT (3.0) CONNECTORS</b>	SHEET No. <b>10 of 10</b>
DOCUMENT NUMBER: <b>TS-43045-001</b>	CREATED / REVISED BY: <b>JDFOX</b>	CHECKED BY: <b>SSOUSEK</b>	APPROVED BY: <b>FSMITH</b>



# TEST SUMMARY

## Micro-Fit (3.0) Connector System (Wire to Wire & Wire to Board – Gold Plating)

### 1.0 SCOPE

This Test Specification covers the 3.00 mm (.118 inch) centerline (pitch) connector series terminated with 20-30 AWG wire using crimp technology and gold plating on the contact interfaces.

### 2.0 PRODUCT DESCRIPTION

#### 2.1 PRODUCT NAME, SERIES, AND PART NUMBER(S)

- Micro-Fit (3.0) Receptacle Series : 43025, 43645, 44133 (BMI)
- Micro-Fit (3.0) Plug Series : 43020, 43640, 44300 (BMI)
- Micro-Fit (3.0) Right Angle & Vertical Header Series : 43045, 43650, 44067
- Micro-Fit (3.0) Compliant Pin Vertical Header Series : 44914
- Micro-Fit (3.0) Female Crimp Terminal Series : 43030
- Micro-Fit (3.0) Male Crimp Terminal Series : 43031
- Micro-Fit (3.0) Female Crimp Terminal with Lubricant : 45773

#### 2.1.1 SERIES NUMBERS TESTED

- Micro-Fit (3.0) Receptacle : 43025
- Micro-Fit (3.0) Plug : 43020
- Micro-Fit (3.0) Right Angle & Vertical Headers : 43045
- Micro-Fit (3.0) Female Crimp Terminal : 43030
- Micro-Fit (3.0) Male Crimp Terminal : 43031
- Micro-Fit (3.0) Female Crimp Terminal with Lubricant : 45773

#### 2.2 DIMENSIONS, MATERIALS, PLATINGS AND MARKINGS

See the appropriate sales drawings for information on dimensions, materials, plating, and markings.

#### 2.3 PRODUCT SPECIFICATION TITLE AND DOCUMENT NUMBER

- Product Specification Micro-Fit Dual Row Connectors  
Document Number: PS-43045
- Product Specification Micro-Fit Single Row Connectors  
Document Number: PS-43650
- Product Specification Micro-Fit (3.0) BMI Floating Connector System  
Document Number: PS-44300-001

<u>REVISION:</u> <b>A1</b>	<u>ECR/ECN INFORMATION:</u> EC No: <b>109530</b> DATE: <b>2016 / 10 /19</b>	<u>TITLE:</u> <b>TEST SUMMARY MICRO-FIT (3.0) DUAL ROW CONNECTORS (GOLD)</b>	<u>SHEET No.</u> <b>1 of 11</b>
<u>DOCUMENT NUMBER:</u> <b>TS-43045-002</b>	<u>CREATED / REVISED BY:</u> <b>JDFOX</b>	<u>CHECKED BY:</u> <b>SSOUSEK</b>	<u>APPROVED BY:</u> <b>FSMITH</b>



# TEST SUMMARY

## 3.0 APPLICABLE DOCUMENTS AND SPECIFICATIONS

### 3.1 TESTING PROCEDURES, SEQUENCES, AND SPECIFICATIONS

NPS-25298-2  
 EIA-364-65A  
 EIA-364-1000.01  
 MIL-STD-202 METHOD 213  
 MIL-STD-202 METHOD 204

### 3.2 OTHER DOCUMENTS AND SPECIFICATIONS

None

## 4.0 QUALIFICATION

Laboratory conditions and sample selection are in accordance with **EIA-364** and **NPS-25298-2**.

## 5.0 PERFORMANCE RESULTS

### 5.1 ELECTRICAL PERFORMANCE RESULTS

#### WIRE TO WIRE CONFIGURATION

ITEM	DESCRIPTION	TREATMENT	REQUIREMENT	MEAN	MINIMUM	MAXIMUM
1A	CONTACT RESISTANCE (LOW LEVEL)	Initial **	---	17.84 mΩ	17.69 mΩ	18.34 mΩ
		After Vibration Δ mΩ	10 milliohms MAXIMUM	0.05 mΩ	-0.49 mΩ	0.46 mΩ
			No Discontinuity	Discontinuity < 1 microsecond		
		After Mechanical Shock Δ mΩ	10 milliohms MAXIMUM	0.12 mΩ	-0.41 mΩ	0.48 mΩ
			No Discontinuity	Discontinuity < 1 microsecond		

NOTE : \*\* A PORTION OF THE MEASUREMENT VALUE IS ATTRIBUTED TO THE BULK RESISTANCE OF THE WIRE USED IN SAMPLE PREPARATION.

#### WIRE TO BOARD CONFIGURATION

ITEM	DESCRIPTION	TREATMENT	REQUIREMENT	MEAN	MINIMUM	MAXIMUM
1B	CONTACT RESISTANCE (LOW LEVEL)	Initial	---	9.85 mΩ	9.66 mΩ	10.02 mΩ
		After Vibration Δ mΩ	10 milliohms MAXIMUM	-0.07 mΩ	-0.21 mΩ	0.00 mΩ
			No Discontinuity	Discontinuity < 1 microsecond		
		After Mechanical Shock Δ mΩ	10 milliohms MAXIMUM	-0.02 mΩ	-0.15 mΩ	0.09 mΩ
			No Discontinuity	Discontinuity < 1 microsecond		

NOTE : SEE APPENDIX "A" FOR TEST SEQUENCE "1" DESCRIPTION

REVISION: <b>A1</b>	ECR/ECN INFORMATION: EC No: 109530 DATE: 2016 / 10 /19	TITLE: <b>TEST SUMMARY MICRO-FIT (3.0) DUAL ROW CONNECTORS (GOLD)</b>	SHEET No. <b>2 of 11</b>
DOCUMENT NUMBER: <b>TS-43045-002</b>	CREATED / REVISED BY: <b>JDFOX</b>	CHECKED BY: <b>SSOUSEK</b>	APPROVED BY: <b>FSMITH</b>



# TEST SUMMARY

## 5.1 ELECTRICAL PERFORMANCE RESULTS (continued)

### WIRE TO WIRE CONFIGURATION

ITEM	DESCRIPTION	TREATMENT	REQUIREMENT	MEAN	MINIMUM	MAXIMUM
2A	Contact Resistance (Low Level)	Initial **	---	17.84 mΩ	17.70 mΩ	17.98 mΩ
		After Thermal Shock Δ mΩ	10 milliohms MAXIMUM	0.05 mΩ	-0.02 mΩ	0.21 mΩ
		After Cyclic Humidity Δ mΩ	10 milliohms MAXIMUM	0.04 mΩ	-0.08 mΩ	0.64 mΩ

NOTE : \*\* A PORTION OF THE MEASUREMENT VALUE IS ATTRIBUTED TO THE BULK RESISTANCE OF THE WIRE USED IN SAMPLE PREPARATION.

### WIRE TO BOARD CONFIGURATION

ITEM	DESCRIPTION	TREATMENT	REQUIREMENT	MEAN	MINIMUM	MAXIMUM
2B	Contact Resistance (Low Level)	Initial	---	5.01 mΩ	4.83 mΩ	5.36 mΩ
		After Thermal Shock Δ mΩ	10 milliohms MAXIMUM	-0.01 mΩ	-0.15 mΩ	0.16 mΩ
		After Cyclic Humidity Δ mΩ	10 milliohms MAXIMUM	-0.02 mΩ	-0.15 mΩ	0.19 mΩ

### ITEM 2C AND 2D:

ALL OF THE SAMPLES USED IN THE SEQUENCE "2" (GROUP 2) INSULATION RESISTANCE AND DIELECTRIC WITHSTANDING VOLTAGE TESTING PASSED WITHOUT FAILURE (WIRE TO WIRE AND WIRE TO BOARD).

NOTE : SEE APPENDIX "A" FOR TEST SEQUENCE "2" DESCRIPTION

### WIRE TO WIRE CONFIGURATION

ITEM	DESCRIPTION	TREATMENT	REQUIREMENT	MEAN	MINIMUM	MAXIMUM
3A	Contact Resistance (Low Level)	Initial **	---	17.84 mΩ	17.64 mΩ	19.99 mΩ
		After Thermal Aging Δ mΩ	10 milliohms MAXIMUM	0.07 mΩ	-1.09 mΩ	0.16 mΩ

NOTE : \*\* A PORTION OF THE MEASUREMENT VALUE IS ATTRIBUTED TO THE BULK RESISTANCE OF THE WIRE USED IN SAMPLE PREPARATION.

REVISION: <b>A1</b>	ECR/ECN INFORMATION: EC No: 109530 DATE: 2016 / 10 /19	TITLE: <b>TEST SUMMARY MICRO-FIT (3.0) DUAL ROW CONNECTORS (GOLD)</b>	SHEET No. <b>3 of 11</b>
DOCUMENT NUMBER: <b>TS-43045-002</b>	CREATED / REVISED BY: <b>JDFOX</b>	CHECKED BY: <b>SSOUSEK</b>	APPROVED BY: <b>FSMITH</b>





# TEST SUMMARY

## 5.1 ELECTRICAL PERFORMANCE RESULTS (continued)

### WIRE TO BOARD CONFIGURATION

ITEM	DESCRIPTION	TREATMENT	REQUIREMENT	MEAN	MINIMUM	MAXIMUM
<b>3B</b>	Contact Resistance (Low Level)	Initial	---	4.98 mΩ	4.87 mΩ	5.20 mΩ
		After Thermal Aging Δ mΩ	10 milliohms MAXIMUM	0.03 mΩ	-0.03 mΩ	0.10 mΩ

SEE APPENDIX "A" FOR TEST SEQUENCE "3" DESCRIPTION

### 43030 FEMALE CRIMP TERMINAL

ITEM	DESCRIPTION	TREATMENT	REQUIREMENT	MEAN	MINIMUM	MAXIMUM
<b>4A</b> <b>L</b> <b>o</b> <b>t</b> <b>1</b>	Contact Resistance (Low Level)	Initial	---	3.27 mΩ	3.15 mΩ	3.41 mΩ
		After Thermal Age Δ mΩ	10 milliohms MAXIMUM	0.02 mΩ	-0.01 mΩ	0.04 mΩ
		After Tensile Strength Δ mΩ	10 milliohms MAXIMUM	0.02 mΩ	-0.02 mΩ	0.04 mΩ

### 43031 MALE CRIMP TERMINAL

ITEM	DESCRIPTION	TREATMENT	REQUIREMENT	MEAN	MINIMUM	MAXIMUM
<b>4B</b> <b>L</b> <b>o</b> <b>t</b> <b>1</b>	Contact Resistance (Low Level)	Initial	---	3.31 mΩ	3.17 mΩ	3.40 mΩ
		After Thermal Age Δ mΩ	10 milliohms MAXIMUM	0.02 mΩ	0.00 mΩ	0.04 mΩ
		After Tensile Strength Δ mΩ	10 milliohms MAXIMUM	0.02 mΩ	0.00 mΩ	0.05 mΩ

NOTE : SEE APPENDIX "A" FOR TEST SEQUENCE "4" DESCRIPTION

REVISION: <b>A1</b>	ECR/ECN INFORMATION: EC No: 109530 DATE: 2016 / 10 /19	TITLE: <b>TEST SUMMARY MICRO-FIT (3.0) DUAL ROW CONNECTORS (GOLD)</b>	SHEET No. <b>4 of 11</b>
DOCUMENT NUMBER: <b>TS-43045-002</b>	CREATED / REVISED BY: <b>JDFOX</b>	CHECKED BY: <b>SSOUSEK</b>	APPROVED BY: <b>FSMITH</b>



# TEST SUMMARY

## 5.1 ELECTRICAL PERFORMANCE RESULTS (continued)

### 43030 FEMALE CRIMP TERMINAL

ITEM	DESCRIPTION	TREATMENT	REQUIREMENT	MEAN	MINIMUM	MAXIMUM
<b>4A</b> <b>L</b> <b>o</b> <b>t</b> <b>2</b>	Contact Resistance (Low Level)	Initial	---	3.45 mΩ	3.24 mΩ	3.74 mΩ
		After Thermal Age Δ mΩ	10 milliohms MAXIMUM	0.00 mΩ	-0.01 mΩ	0.02 mΩ
		After Gas Tightness Δ mΩ	10 milliohms MAXIMUM	0.01 mΩ	0.00 mΩ	0.05 mΩ

### 43031 MALE CRIMP TERMINAL

ITEM	DESCRIPTION	TREATMENT	REQUIREMENT	MEAN	MINIMUM	MAXIMUM
<b>4B</b> <b>L</b> <b>o</b> <b>t</b> <b>2</b>	Contact Resistance (Low Level)	Initial	---	3.48 mΩ	3.25 mΩ	3.73 mΩ
		After Thermal Age Δ mΩ	10 milliohms MAXIMUM	0.01 mΩ	-0.01 mΩ	0.03 mΩ
		After Gas Tightness Δ mΩ	10 milliohms MAXIMUM	0.02 mΩ	-0.01 mΩ	0.05 mΩ

NOTE : SEE APPENDIX "A" FOR TEST SEQUENCE "4" DESCRIPTION

REVISION: <b>A1</b>	ECR/ECN INFORMATION: EC No: 109530 DATE: 2016 / 10 /19	TITLE: <b>TEST SUMMARY MICRO-FIT (3.0) DUAL ROW CONNECTORS (GOLD)</b>	SHEET No. <b>5 of 11</b>
DOCUMENT NUMBER: <b>TS-43045-002</b>	CREATED / REVISED BY: <b>JDFOX</b>	CHECKED BY: <b>SSOUSEK</b>	APPROVED BY: <b>FSMITH</b>



# TEST SUMMARY

## 5.1 ELECTRICAL PERFORMANCE RESULTS (continued)

**NOTE:** The following Mixed Flowing Gas Testing results are for the MicroFit Female Crimp Terminal 45773 series (43030 series terminal with environmental lube applied).

### WIRE TO WIRE CONFIGURATION

ITEM	DESCRIPTION	TREATMENT	REQUIREMENT	MEAN	MINIMUM	MAXIMUM
<b>5A</b>	Contact Resistance (Low Level)	Initial **	---	18.16 mΩ	18.03 mΩ	18.59 mΩ
		After Durability Δ mΩ	10 milliohms MAXIMUM	-0.12 mΩ	-0.67 mΩ	0.03 mΩ
		After Unmated 5 days Δ mΩ	10 milliohms MAXIMUM	-0.05 mΩ	-0.57 mΩ	0.65 mΩ
		After Unmated 10 days Δ mΩ	10 milliohms MAXIMUM	0.05 mΩ	-1.10 mΩ	1.05 mΩ
		After Mated 15 days Δ mΩ	10 milliohms MAXIMUM	0.04 mΩ	-0.12 mΩ	0.24 mΩ
		After Mated 20 days Δ mΩ	10 milliohms MAXIMUM	-0.01 mΩ	-0.99 mΩ	2.57 mΩ
		After Durability Δ mΩ	10 milliohms MAXIMUM	-0.22 mΩ	-2.58 mΩ	0.50 mΩ

**NOTE :** \*\* A PORTION OF THE MEASUREMENT VALUE IS ATTRIBUTED TO THE BULK RESISTANCE OF THE WIRE USED IN SAMPLE PREPARATION.

### WIRE TO BOARD CONFIGURATION

ITEM	DESCRIPTION	TREATMENT	REQUIREMENT	MEAN	MINIMUM	MAXIMUM
<b>5B</b>	Contact Resistance (Low Level)	Initial	---	5.24 mΩ	5.09 mΩ	5.42 mΩ
		After Durability Δ mΩ	10 milliohms MAXIMUM	-0.01 mΩ	-0.32 mΩ	0.24 mΩ
		After Unmated 5 days Δ mΩ	10 milliohms MAXIMUM	0.03 mΩ	-0.30 mΩ	1.03 mΩ
		After Unmated 10 days Δ mΩ	10 milliohms MAXIMUM	0.00 mΩ	-0.36 mΩ	0.18 mΩ
		After Mated 15 days Δ mΩ	10 milliohms MAXIMUM	0.09 mΩ	-0.33 mΩ	0.58 mΩ
		After Mated 20 days Δ mΩ	10 milliohms MAXIMUM	0.04 mΩ	-0.29 mΩ	0.42 mΩ
		After Durability Δ mΩ	10 milliohms MAXIMUM	0.11 mΩ	-0.11 mΩ	0.39 mΩ

**NOTE :** SEE APPENDIX "A" FOR TEST SEQUENCE "5" DESCRIPTION

REVISION: <b>A1</b>	ECR/ECN INFORMATION: EC No: 109530 DATE: 2016 / 10 /19	TITLE: <b>TEST SUMMARY MICRO-FIT (3.0) DUAL ROW CONNECTORS (GOLD)</b>	SHEET No. <b>6 of 11</b>
DOCUMENT NUMBER: <b>TS-43045-002</b>	CREATED / REVISED BY: <b>JDFOX</b>	CHECKED BY: <b>SSOUSEK</b>	APPROVED BY: <b>FSMITH</b>



# TEST SUMMARY

## 5.2 MECHANICAL PERFORMANCE RESULTS

ITEM	DESCRIPTION	TREATMENT	REQUIREMENT	MEAN	MINIMUM	MAXIMUM
<b>3C</b>	Contact Normal Force (grams)	Initial	275 g Min	443 g	413 g	466 g
		After Thermal Age	275 g Min	292 g	285 g	297 g

NOTE : SEE APPENDIX "A" FOR TEST SEQUENCE "3" DESCRIPTION

REVISION: <b>A1</b>	ECR/ECN INFORMATION: EC No: <b>109530</b> DATE: <b>2016 / 10 /19</b>	TITLE: <b>TEST SUMMARY MICRO-FIT (3.0) DUAL ROW CONNECTORS (GOLD)</b>	SHEET No. <b>7 of 11</b>
DOCUMENT NUMBER: <b>TS-43045-002</b>	CREATED / REVISED BY: <b>JDFOX</b>	CHECKED BY: <b>SSOUSEK</b>	APPROVED BY: <b>FSMITH</b>



# TEST SUMMARY

## APPENDIX A TEST SEQUENCES

<u>REVISION:</u> <b>A1</b>	<u>ECR/ECN INFORMATION:</u> EC No: <b>109530</b> DATE: <b>2016 / 10 /19</b>	<u>TITLE:</u> <b>TEST SUMMARY MICRO-FIT (3.0) DUAL ROW CONNECTORS (GOLD)</b>	<u>SHEET No.</u> <b>8 of 11</b>
<u>DOCUMENT NUMBER:</u> <b>TS-43045-002</b>	<u>CREATED / REVISED BY:</u> <b>JDFOX</b>	<u>CHECKED BY:</u> <b>SSOUSEK</b>	<u>APPROVED BY:</u> <b>FSMITH</b>



# TEST SUMMARY

## A.1 TEST SEQUENCES

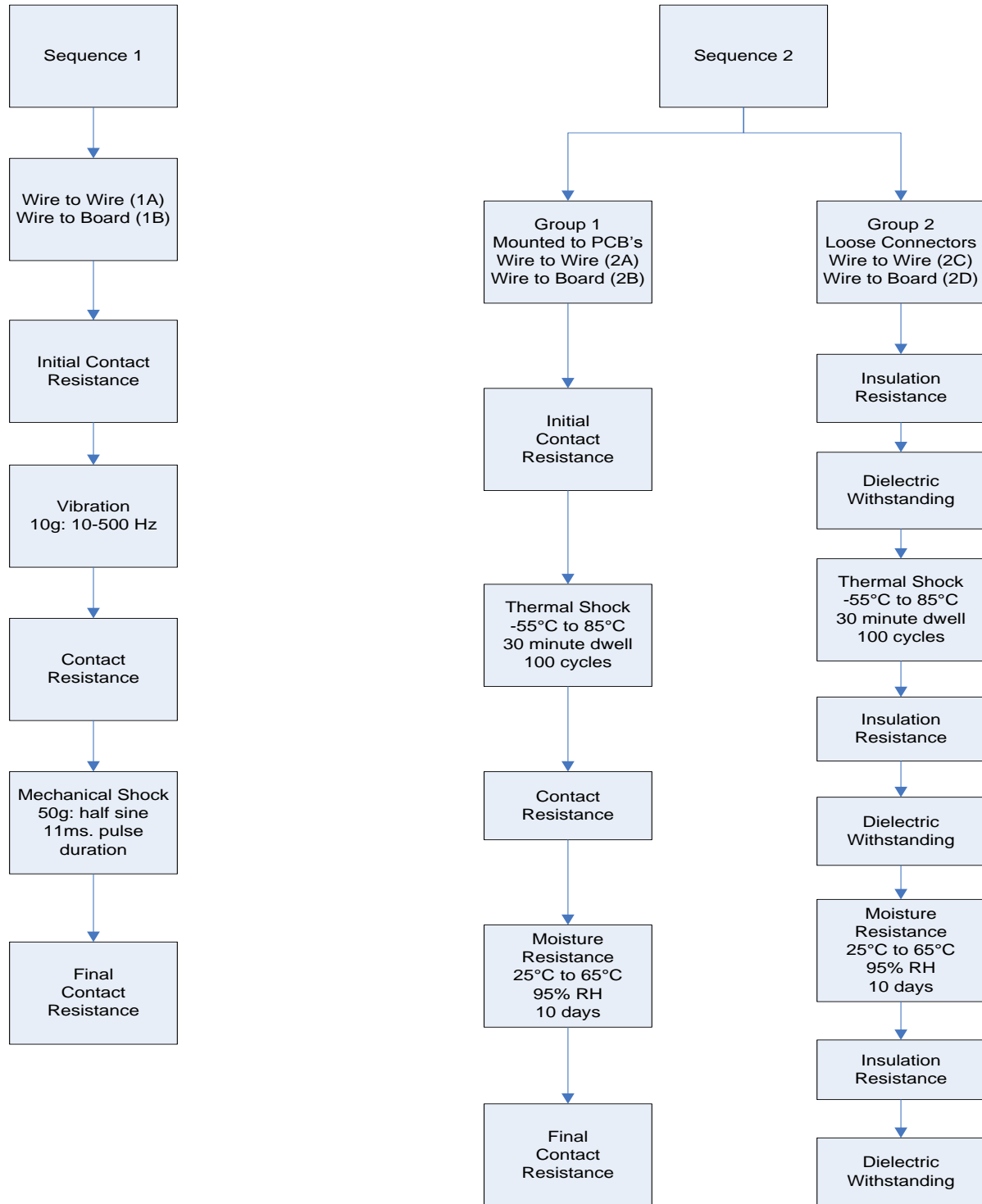

REVISION: <b>A1</b>	ECR/ECN INFORMATION: EC No: <b>109530</b> DATE: <b>2016 / 10 /19</b>	TITLE: <b>TEST SUMMARY MICRO-FIT (3.0) DUAL ROW CONNECTORS (GOLD)</b>	SHEET No. <b>9 of 11</b>
DOCUMENT NUMBER: <b>TS-43045-002</b>	CREATED / REVISED BY: <b>JDFOX</b>	CHECKED BY: <b>SSOUSEK</b>	APPROVED BY: <b>FSMITH</b>



# TEST SUMMARY

## A.1 TEST SEQUENCES (continued)

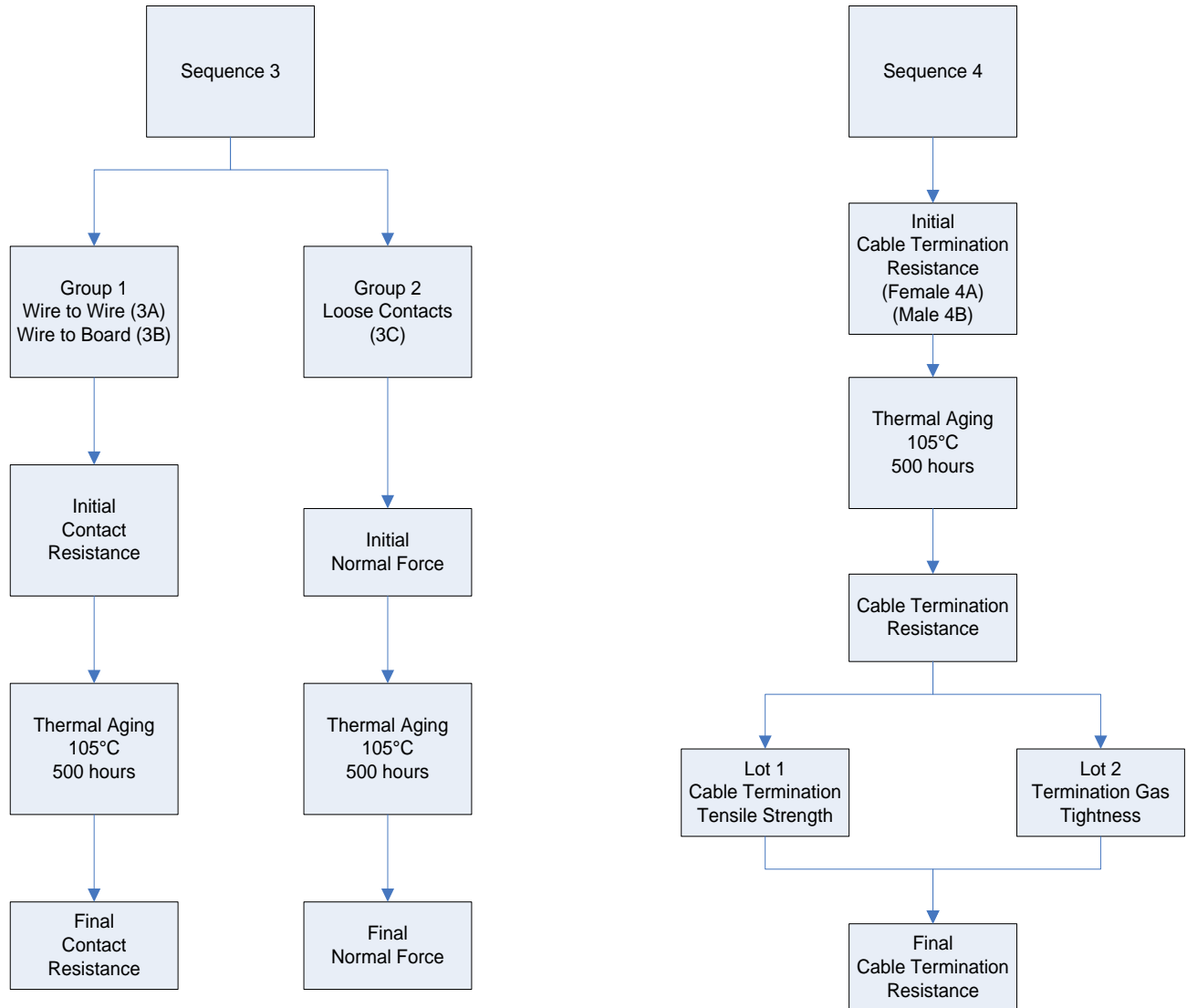

REVISION: <b>A1</b>	ECR/ECN INFORMATION: EC No: <b>109530</b> DATE: <b>2016 / 10 /19</b>	TITLE: <b>TEST SUMMARY MICRO-FIT (3.0) DUAL ROW CONNECTORS (GOLD)</b>	SHEET No. <b>10 of 11</b>
DOCUMENT NUMBER: <b>TS-43045-002</b>	CREATED / REVISED BY: <b>JDFOX</b>	CHECKED BY: <b>SSOUSEK</b>	APPROVED BY: <b>FSMITH</b>



# TEST SUMMARY

## A.1 TEST SEQUENCES (continued)

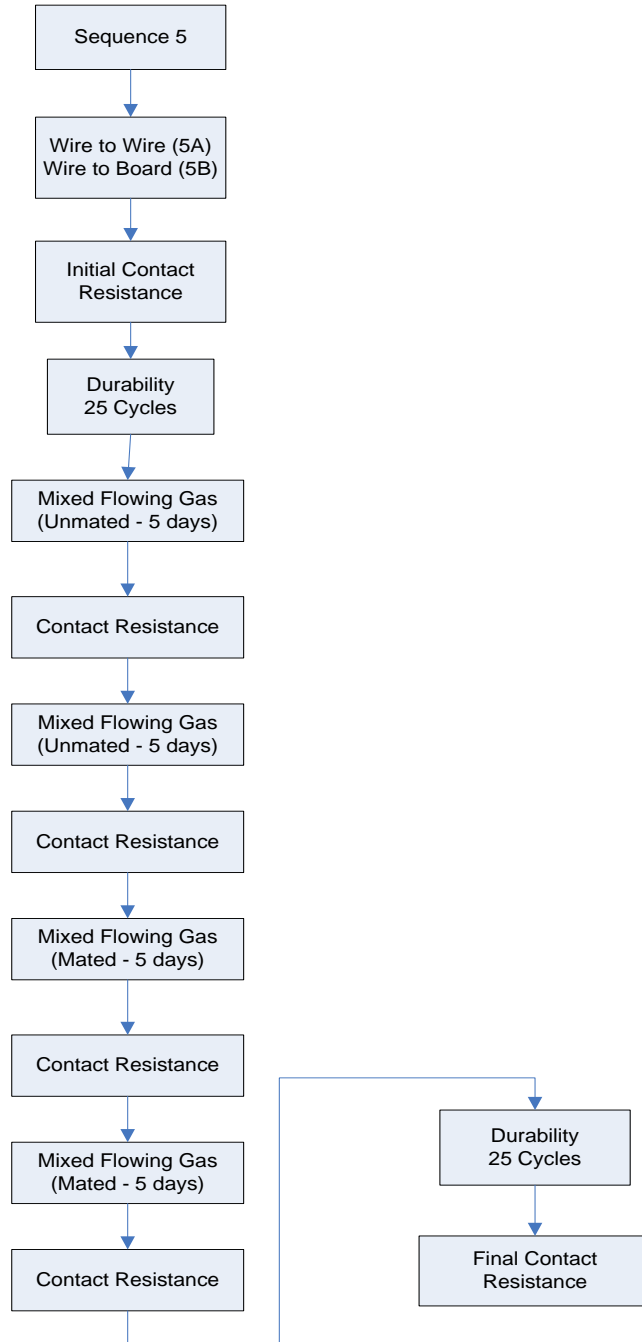

REVISION: <b>A1</b>	ECR/ECN INFORMATION: EC No: <b>109530</b> DATE: <b>2016 / 10 /19</b>	TITLE: <b>TEST SUMMARY MICRO-FIT (3.0) DUAL ROW CONNECTORS (GOLD)</b>	SHEET No. <b>11 of 11</b>
DOCUMENT NUMBER: <b>TS-43045-002</b>	CREATED / REVISED BY: <b>JDFOX</b>	CHECKED BY: <b>SSOUSEK</b>	APPROVED BY: <b>FSMITH</b>





# TEST SUMMARY

## LOW FORCE MICRO-FIT SERIES (46235)



### 1.0 SCOPE

This Test Summary covers the 3.00 mm (.118 inch) centerline (pitch) receptacles terminated with 46235 low force crimp terminals when mated with either printed circuit board (PCB) headers or plugs terminated with 20 to 30 AWG wire using crimp technology.

### 2.0 PRODUCT DESCRIPTION

#### 2.1 PRODUCT NAME, SERIES, AND PART NUMBER(S)

Micro-Fit (3.0) Receptacle Series : 43025, 43645, 44133 (BMI)

Micro-Fit (3.0) Plug Series : 43020, 43640, 44300 (BMI)

Micro-Fit (3.0) Right Angle & Vertical Header Series : 43045, 43650, 44067

Micro-Fit (3.0) Compliant Pin Vertical Header Series : 44914

Micro-Fit (3.0) Female Crimp Terminal Series : 46235

Micro-Fit (3.0) Male Crimp Terminal Series : 43031

#### 2.1.1 SERIES NUMBERS TESTED

Micro-Fit (3.0) Receptacle : 43025

Micro-Fit (3.0) Plug : 43020

Micro-Fit (3.0) Right Angle & Vertical Headers : 43045

Micro-Fit (3.0) Female Crimp Terminal : 46235

Micro-Fit (3.0) Male Crimp Terminal : 43031

#### 2.2 DIMENSIONS, MATERIALS, PLATINGS AND MARKINGS

Refer to the appropriate sales drawings for information on dimensions, materials, platings and markings.

#### 2.3 PRODUCT SPECIFICATION TITLE AND DOCUMENT NUMBER

Title: Product Specification for Micro-fit Low Mate Force Connector System

Document No.: PS-46235-001

REVISION: <b>D1</b>	ECR/ECN INFORMATION: EC No: 109530 DATE: 2016 / 10 / 19	TITLE: <b>TEST SUMMARY FOR 46235 LOW FORCE MICRO-FIT CONNECTOR SYSTEM</b>	SHEET No. <b>1 of 18</b>
DOCUMENT NUMBER: <b>TS-46235-001</b>	CREATED / REVISED BY: <b>JDFOX</b>	CHECKED BY: <b>SSOUSEK</b>	APPROVED BY: <b>FSMITH</b>



# TEST SUMMARY

## 3.0 APPLICABLE DOCUMENTS AND SPECIFICATIONS

### 3.1 TESTING SEQUENCES AND PROCEDURES

Reference Appendix 1

### 3.2 OTHER DOCUMENTS AND SPECIFICATIONS

SD-46235-001

PS-46235-001

## 4.0 QUALIFICATION

Laboratory conditions and sample selection are in accordance with EIA-364.

## 5.0 PERFORMANCE

### 5.1 ELECTRICAL/ENVIRONMENTAL PERFORMANCE RESULTS

(Note that measured LLCR values are for one mated interface)

DESCRIPTION	WIRE GAUGE	REQUIREMENT	AMPERAGE
Temperature Rise & Current Cycling	30 awg	30° C Max. Temperature Rise	2.5 amps (2 circuit)
	26 awg	30° C Max. Temperature Rise	3.0 amps (2 circuit)
	24 awg	30° C Max. Temperature Rise	4.0 amps (2 circuit)
	20 awg	30° C Max. Temperature Rise	5.5 amps (2 circuit)

REVISION: <b>D1</b>	ECR/ECN INFORMATION: EC No: 109530 DATE: 2016 / 10 / 19	TITLE: <b>TEST SUMMARY FOR 46235 LOW FORCE MICRO-FIT CONNECTOR SYSTEM</b>	SHEET No. <b>2 of 18</b>
DOCUMENT NUMBER: <b>TS-46235-001</b>	CREATED / REVISED BY: <b>JDFOX</b>	CHECKED BY: <b>SSOUSEK</b>	APPROVED BY: <b>FSMITH</b>



# TEST SUMMARY

## 5.1 ELECTRICAL/ENVIRONMENTAL PERFORMANCE RESULTS (cont)

(Note that measured LLCR values are for one mated interface)

WIRE TO BOARD						
ITEM	DESCRIPTION	TREATMENT	REQUIREMENT	MEAN	MINIMUM	MAXIMUM
<b>G R O U P  1</b>	Contact Resistance (Low Level)	Initial	13.0 mΩ Nominal no limit set	<b>12.83 mΩ</b>	<b>12.03 mΩ</b>	<b>13.28 mΩ</b>
		After Initial Durability (Preconditioning) (25 cycles)	20 mΩ MAXIMUM*	<b>0.03 mΩ</b>	<b>-0.40 mΩ</b>	<b>0.63 mΩ</b>
		After Temp Life (240 hrs. @ 105°C)	20 mΩ MAXIMUM*	<b>0.06 mΩ</b>	<b>-0.39 mΩ</b>	<b>0.61 mΩ</b>
		After Reseating (3x M/U)	20 mΩ MAXIMUM*	<b>0.07 mΩ</b>	<b>-0.32 mΩ</b>	<b>0.81 mΩ</b>

\* change from initial

WIRE TO WIRE						
ITEM	DESCRIPTION	TREATMENT	REQUIREMENT	MEAN	MINIMUM	MAXIMUM
<b>G R O U P  1</b>	Contact Resistance (Low Level)	Initial	13.0 mΩ Nominal no limit set	<b>12.70 mΩ</b>	<b>11.82 mΩ</b>	<b>13.52 mΩ</b>
		After Initial Durability (Preconditioning) (25 cycles)	20 mΩ MAXIMUM*	<b>0.12 mΩ</b>	<b>-0.31 mΩ</b>	<b>0.78 mΩ</b>
		After Temp Life (240 hrs. @ 105°C)	20 mΩ MAXIMUM*	<b>0.13 mΩ</b>	<b>-0.27 mΩ</b>	<b>0.54 mΩ</b>
		After Reseating (3x M/U)	20 mΩ MAXIMUM*	<b>0.42 mΩ</b>	<b>-0.13 mΩ</b>	<b>1.86 mΩ</b>

\* change from initial

REVISION: <b>D1</b>	ECR/ECN INFORMATION: EC No: 109530 DATE: 2016 / 10 / 19	TITLE: <b>TEST SUMMARY FOR 46235 LOW FORCE MICRO-FIT CONNECTOR SYSTEM</b>	SHEET No. <b>3 of 18</b>
DOCUMENT NUMBER: <b>TS-46235-001</b>	CREATED / REVISED BY: <b>JDFOX</b>	CHECKED BY: <b>SSOUSEK</b>	APPROVED BY: <b>FSMITH</b>



# TEST SUMMARY

## 5.1 ELECTRICAL/ENVIRONMENTAL PERFORMANCE RESULTS (cont)

(Note that measured LLCR values are for one mated interface)

WIRE TO BOARD						
ITEM	DESCRIPTION	TREATMENT	REQUIREMENT	MEAN	MINIMUM	MAXIMUM
<b>G R O U P  2</b>	Contact Resistance (Low Level)	Initial	13.0 mΩ Nominal no limit set	12.99 mΩ	12.58 mΩ	13.51 mΩ
		After Initial Durability (Preconditioning) (25 cycles)	20 mΩ MAXIMUM*	0.01 mΩ	-0.33 mΩ	0.62 mΩ
		After Thermal Shock	20 mΩ MAXIMUM*	-0.15 mΩ	-0.48 mΩ	0.20 mΩ
		After Cyclic Temp and Humidity	20 mΩ MAXIMUM*	-0.14 mΩ	-0.51 mΩ	0.64 mΩ
		After Reseating (3x M/U)	20 mΩ MAXIMUM*	-0.03 mΩ	-0.39 mΩ	0.52 mΩ

\* change from initial

WIRE TO WIRE						
ITEM	DESCRIPTION	TREATMENT	REQUIREMENT	MEAN	MINIMUM	MAXIMUM
<b>G R O U P  2</b>	Contact Resistance (Low Level)	Initial	13.0 mΩ Nominal no limit set	13.01 mΩ	12.53 mΩ	13.57 mΩ
		After Initial Durability (Preconditioning) (25 cycles)	20 mΩ MAXIMUM*	0.23 mΩ	-0.41 mΩ	0.66 mΩ
		After Thermal Shock	20 mΩ MAXIMUM*	0.11 mΩ	-0.34 mΩ	0.56 mΩ
		After Cyclic Temp and Humidity	20 mΩ MAXIMUM*	0.10 mΩ	-0.41 mΩ	0.51 mΩ
		After Reseating (3x M/U)	20 mΩ MAXIMUM*	-0.29 mΩ	-0.34 mΩ	0.97 mΩ

\* change from initial

REVISION: <b>D1</b>	ECR/ECN INFORMATION: EC No: 109530 DATE: 2016 / 10 / 19	TITLE: <b>TEST SUMMARY FOR 46235 LOW FORCE MICRO-FIT CONNECTOR SYSTEM</b>	SHEET No. <b>4 of 18</b>
DOCUMENT NUMBER: <b>TS-46235-001</b>	CREATED / REVISED BY: <b>JDFOX</b>	CHECKED BY: <b>SSOUSEK</b>	APPROVED BY: <b>FSMITH</b>



# TEST SUMMARY

## 5.1 ELECTRICAL/ENVIRONMENTAL PERFORMANCE RESULTS (cont)

(Note that measured LLCR values are for one mated interface)

WIRE TO BOARD						
ITEM	DESCRIPTION	TREATMENT	REQUIREMENT	MEAN	MINIMUM	MAXIMUM
<b>G R O U P  3</b>	Contact Resistance (Low Level)	Initial	13.0 mΩ Nominal no limit set	<b>12.94</b> mΩ	<b>12.23</b> mΩ	<b>13.61</b> mΩ
		After Initial Durability (Preconditioning) (25 cycles)	20 mΩ MAXIMUM*	<b>0.02</b> mΩ	<b>-0.51</b> mΩ	<b>0.58</b> mΩ
		After Temp Life (120 hrs. @ 105°C)	20 mΩ MAXIMUM*	<b>0.03</b> mΩ	<b>-0.50</b> mΩ	<b>0.35</b> mΩ
		Vibration	20 mΩ MAXIMUM*	<b>0.04</b> mΩ	<b>-0.29</b> mΩ	<b>0.82</b> mΩ
		Mechanical Shock	20 mΩ MAXIMUM*	<b>0.03</b> mΩ	<b>-0.53</b> mΩ	<b>0.34</b> mΩ

\* change from initial

WIRE TO WIRE						
ITEM	DESCRIPTION	TREATMENT	REQUIREMENT	MEAN	MINIMUM	MAXIMUM
<b>G R O U P  3</b>	Contact Resistance (Low Level)	Initial	13.0 mΩ Nominal no limit set	<b>13.05</b> mΩ	<b>12.37</b> mΩ	<b>13.71</b> mΩ
		After Initial Durability (Preconditioning) (25 cycles)	20 mΩ MAXIMUM*	<b>0.15</b> mΩ	<b>-0.25</b> mΩ	<b>0.61</b> mΩ
		After Temp Life (120 hrs. @ 105°C)	20 mΩ MAXIMUM*	<b>0.28</b> mΩ	<b>-0.21</b> mΩ	<b>0.76</b> mΩ
		Vibration	20 mΩ MAXIMUM*	<b>0.44</b> mΩ	<b>0.07</b> mΩ	<b>0.93</b> mΩ
		Mechanical Shock	20 mΩ MAXIMUM*	<b>0.47</b> mΩ	<b>0.03</b> mΩ	<b>1.72</b> mΩ

\* change from initial

REVISION: <b>D1</b>	ECR/ECN INFORMATION: EC No: <b>109530</b> DATE: <b>2016 / 10 / 19</b>	TITLE: <b>TEST SUMMARY FOR 46235 LOW FORCE MICRO-FIT CONNECTOR SYSTEM</b>	SHEET No. <b>5 of 18</b>
DOCUMENT NUMBER: <b>TS-46235-001</b>	CREATED / REVISED BY: <b>JDFOX</b>	CHECKED BY: <b>SSOUSEK</b>	APPROVED BY: <b>FSMITH</b>



# TEST SUMMARY

## 5.1 ELECTRICAL/ENVIRONMENTAL PERFORMANCE RESULTS (cont)

(Note that measured LLCR values are for one mated interface)

WIRE TO BOARD, 15μ" Au						
ITEM	DESCRIPTION	TREATMENT	REQUIREMENT	MEAN	MINIMUM	MAXIMUM
<b>G R O U P  4</b>	Contact Resistance (Low Level)	Initial	13.0 mΩ Nominal no limit set	<b>12.94</b> mΩ	<b>12.51</b> mΩ	<b>13.53</b> mΩ
		After Initial Durability (Preconditioning) (25 cycles)	20 mΩ MAXIMUM*	<b>0.03</b> mΩ	<b>-0.52</b> mΩ	<b>0.90</b> mΩ
		After Temp. Life (120 hrs. @ 105 C)	20 mΩ MAXIMUM*	<b>0.10</b> mΩ	<b>-0.28</b> mΩ	<b>1.31</b> mΩ
		After Mixed Flowing Gas Testing (7 days Unmated)	20 mΩ MAXIMUM*	<b>1.11</b> mΩ	<b>0.21</b> mΩ	<b>4.92</b> mΩ
		After Mixed Flowing Gas Testing (3 days Mated)	20 mΩ MAXIMUM*	<b>1.40</b> mΩ	<b>0.26</b> mΩ	<b>6.39</b> mΩ
		After Thermal Shock	20 mΩ MAXIMUM*	<b>1.01</b> mΩ	<b>-0.41</b> mΩ	<b>33.45</b> mΩ
		After Reseating (3x M/U)	20 mΩ MAXIMUM*	<b>0.88</b> mΩ	<b>-0.17</b> mΩ	<b>29.43</b> mΩ

\* change from initial

REVISION: <b>D1</b>	ECR/ECN INFORMATION: EC No: <b>109530</b> DATE: <b>2016 / 10 / 19</b>	TITLE: <b>TEST SUMMARY FOR 46235 LOW FORCE MICRO-FIT CONNECTOR SYSTEM</b>	SHEET No. <b>6 of 18</b>
DOCUMENT NUMBER: <b>TS-46235-001</b>	CREATED / REVISED BY: <b>JDFOX</b>	CHECKED BY: <b>SSOUSEK</b>	APPROVED BY: <b>FSMITH</b>



# TEST SUMMARY

## 5.1 ELECTRICAL/ENVIRONMENTAL PERFORMANCE RESULTS (cont)

(Note that measured LLCR values are for one mated interface)

WIRE TO BOARD, 30μ" Au						
ITEM	DESCRIPTION	TREATMENT	REQUIREMENT	MEAN	MINIMUM	MAXIMUM
<b>G R O U P  4</b>	Contact Resistance (Low Level)	Initial	13.0 mΩ Nominal no limit set	<b>12.80</b> mΩ	<b>12.40</b> mΩ	<b>13.34</b> mΩ
		After Initial Durability (Preconditioning) (25 cycles)	20 mΩ MAXIMUM*	<b>0.02</b> mΩ	<b>-0.42</b> mΩ	<b>0.38</b> mΩ
		After Temp. Life (120 hrs. @ 105 C)	20 mΩ MAXIMUM*	<b>-0.01</b> mΩ	<b>-0.42</b> mΩ	<b>0.34</b> mΩ
		After Mixed Flowing Gas Testing (7 days Unmated)	20 mΩ MAXIMUM*	<b>0.69</b> mΩ	<b>-0.25</b> mΩ	<b>2.61</b> mΩ
		After Mixed Flowing Gas Testing (3 days Mated)	20 mΩ MAXIMUM*	<b>0.71</b> mΩ	<b>0.08</b> mΩ	<b>2.79</b> mΩ
		After Thermal Shock	20 mΩ MAXIMUM*	<b>0.26</b> mΩ	<b>-0.41</b> mΩ	<b>1.53</b> mΩ
		After Reseating (3x M/U)	20 mΩ MAXIMUM*	<b>0.60</b> mΩ	<b>-0.30</b> mΩ	<b>2.11</b> mΩ

\* change from initial

REVISION: <b>D1</b>	ECR/ECN INFORMATION: EC No: <b>109530</b> DATE: <b>2016 / 10 / 19</b>	TITLE: <b>TEST SUMMARY FOR 46235 LOW FORCE MICRO-FIT CONNECTOR SYSTEM</b>	SHEET No. <b>7 of 18</b>
DOCUMENT NUMBER: <b>TS-46235-001</b>	CREATED / REVISED BY: <b>JDFOX</b>	CHECKED BY: <b>SSOUSEK</b>	APPROVED BY: <b>FSMITH</b>



# TEST SUMMARY

## 5.1 ELECTRICAL/ENVIRONMENTAL PERFORMANCE RESULTS (cont)

(Note that measured LLCR values are for one mated interface)

WIRE TO WIRE, 15μ" Au						
ITEM	DESCRIPTION	TREATMENT	REQUIREMENT	MEAN	MINIMUM	MAXIMUM
<b>G R O U P  4</b>	Contact Resistance (Low Level)	Initial	13.0 mΩ Nominal no limit set	<b>13.05</b> mΩ	<b>12.13</b> mΩ	<b>14.26</b> mΩ
		After Initial Durability (Preconditioning) (25 cycles)	20 mΩ MAXIMUM*	<b>0.01</b> mΩ	<b>-0.35</b> mΩ	<b>0.44</b> mΩ
		After Temp. Life (120 hrs. @ 105 C)	20 mΩ MAXIMUM*	<b>0.08</b> mΩ	<b>-0.37</b> mΩ	<b>0.46</b> mΩ
		After Mixed Flowing Gas Testing (7 days Unmated)	20 mΩ MAXIMUM*	<b>2.07</b> mΩ	<b>-0.52</b> mΩ	<b>10.28</b> mΩ
		After Mixed Flowing Gas Testing (3 days Mated)	20 mΩ MAXIMUM*	<b>1.61</b> mΩ	<b>0.41</b> mΩ	<b>5.39</b> mΩ
		After Thermal Shock	20 mΩ MAXIMUM*	<b>3.23</b> mΩ	<b>0.28</b> mΩ	<b>33.62</b> mΩ
		After Reseating (3x M/U)	20 mΩ MAXIMUM*	<b>2.67</b> mΩ	<b>0.20</b> mΩ	<b>12.65</b> mΩ

\* change from initial

REVISION: <b>D1</b>	ECR/ECN INFORMATION: EC No: <b>109530</b> DATE: <b>2016 / 10 / 19</b>	TITLE: <b>TEST SUMMARY FOR 46235 LOW FORCE MICRO-FIT CONNECTOR SYSTEM</b>	SHEET No. <b>8 of 18</b>
DOCUMENT NUMBER: <b>TS-46235-001</b>	CREATED / REVISED BY: <b>JDFOX</b>	CHECKED BY: <b>SSOUSEK</b>	APPROVED BY: <b>FSMITH</b>





# TEST SUMMARY

## 5.1 ELECTRICAL/ENVIRONMENTAL PERFORMANCE RESULTS (cont)

(Note that measured LLCR values are for one mated interface)

WIRE TO WIRE, 30μ" Au						
ITEM	DESCRIPTION	TREATMENT	REQUIREMENT	MEAN	MINIMUM	MAXIMUM
<b>G R O U P  4</b>	Contact Resistance (Low Level)	Initial	13.0 mΩ Nominal no limit set	<b>12.63</b> mΩ	<b>12.00</b> mΩ	<b>13.38</b> mΩ
		After Initial Durability (Preconditioning) (25 cycles)	20 mΩ MAXIMUM*	<b>0.14</b> mΩ	<b>-0.31</b> mΩ	<b>0.62</b> mΩ
		After Temp. Life (120 hrs. @ 105 C)	20 mΩ MAXIMUM*	<b>0.07</b> mΩ	<b>-0.39</b> mΩ	<b>0.55</b> mΩ
		After Mixed Flowing Gas Testing (7 days Unmated)	20 mΩ MAXIMUM*	<b>1.05</b> mΩ	<b>0.05</b> mΩ	<b>5.01</b> mΩ
		After Mixed Flowing Gas Testing (3 days Mated)	20 mΩ MAXIMUM*	<b>1.10</b> mΩ	<b>0.08</b> mΩ	<b>7.13</b> mΩ
		After Thermal Shock	20 mΩ MAXIMUM*	<b>0.86</b> mΩ	<b>-0.03</b> mΩ	<b>8.26</b> mΩ
		After Reseating (3x M/U)	20 mΩ MAXIMUM*	<b>1.34</b> mΩ	<b>0.23</b> mΩ	<b>3.88</b> mΩ

\* change from initial

REVISION: <b>D1</b>	ECR/ECN INFORMATION: EC No: <b>109530</b> DATE: <b>2016 / 10 / 19</b>	TITLE: <b>TEST SUMMARY FOR 46235 LOW FORCE MICRO-FIT CONNECTOR SYSTEM</b>	SHEET No. <b>9 of 18</b>
DOCUMENT NUMBER: <b>TS-46235-001</b>	CREATED / REVISED BY: <b>JDFOX</b>	CHECKED BY: <b>SSOUSEK</b>	APPROVED BY: <b>FSMITH</b>



# TEST SUMMARY

## 5.1 ELECTRICAL/ENVIRONMENTAL PERFORMANCE RESULTS (cont)

(Note that measured LLCR values are for one mated interface)

WIRE TO BOARD						
ITEM	DESCRIPTION	TREATMENT	REQUIREMENT	MEAN	MINIMUM	MAXIMUM
<b>G R O U P  5</b>	Contact Resistance (Low Level)	Initial	13.0 mΩ Nominal no limit set	<b>12.90</b> mΩ	<b>12.39</b> mΩ	<b>13.34</b> mΩ
		After Initial Durability (Preconditioning) (25 cycles)	20 mΩ MAXIMUM*	<b>0.06</b> mΩ	<b>-0.31</b> mΩ	<b>0.70</b> mΩ
		After Temp. Life (120 hrs. @ 105 C)	20 mΩ MAXIMUM*	<b>0.27</b> mΩ	<b>-0.15</b> mΩ	<b>1.08</b> mΩ
		After Thermal Cycling	20 mΩ MAXIMUM*	<b>-0.03</b> mΩ	<b>-0.37</b> mΩ	<b>0.63</b> mΩ
		After Thermal Shock	20 mΩ MAXIMUM*	<b>0.12</b> mΩ	<b>-0.37</b> mΩ	<b>0.61</b> mΩ

\* change from initial

WIRE TO WIRE						
ITEM	DESCRIPTION	TREATMENT	REQUIREMENT	MEAN	MINIMUM	MAXIMUM
<b>G R O U P  5</b>	Contact Resistance (Low Level)	Initial	13.0 mΩ Nominal no limit set	<b>12.81</b> mΩ	<b>12.00</b> mΩ	<b>13.62</b> mΩ
		After Initial Durability (Preconditioning) (25 cycles)	20 mΩ MAXIMUM*	<b>0.08</b> mΩ	<b>-0.50</b> mΩ	<b>0.62</b> mΩ
		After Temp. Life (120 hrs. @ 105 C)	20 mΩ MAXIMUM*	<b>0.22</b> mΩ	<b>-0.62</b> mΩ	<b>0.84</b> mΩ
		After Thermal Cycling	20 mΩ MAXIMUM*	<b>0.23</b> mΩ	<b>-0.48</b> mΩ	<b>0.85</b> mΩ
		After Thermal Shock	20 mΩ MAXIMUM*	<b>0.35</b> mΩ	<b>-0.54</b> mΩ	<b>1.42</b> mΩ

\* change from initial

REVISION: <b>D1</b>	ECR/ECN INFORMATION: EC No: <b>109530</b> DATE: <b>2016 / 10 / 19</b>	TITLE: <b>TEST SUMMARY FOR 46235 LOW FORCE MICRO-FIT CONNECTOR SYSTEM</b>	SHEET No. <b>10 of 18</b>
DOCUMENT NUMBER: <b>TS-46235-001</b>	CREATED / REVISED BY: <b>JDFOX</b>	CHECKED BY: <b>SSOUSEK</b>	APPROVED BY: <b>FSMITH</b>

# TEST SUMMARY

## 5.1 ELECTRICAL/ENVIRONMENTAL PERFORMANCE RESULTS (cont)

15μ" Au – 40 cycles				
ITEM	DESCRIPTION	TREATMENT	REQUIREMENT	RESULTS
<b>G R O U P  7</b>	Dielectric Withstanding Voltage (DWV)	Durability (40 M/U cycles) 2200 VAC	No breakdown or flashover	PASS

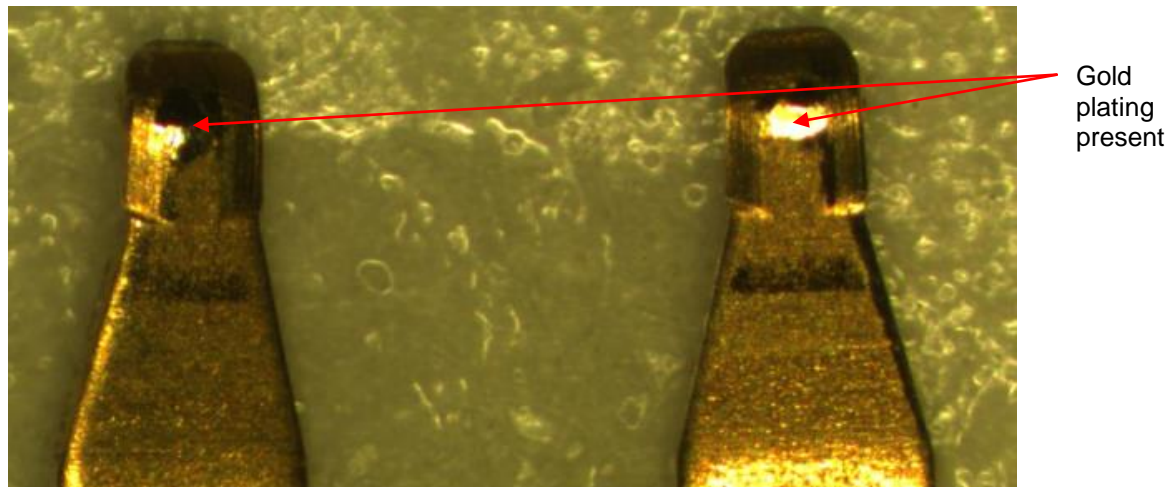

Figure 1 – Contact area shown after 40 cycles

REVISION: <b>D1</b>	ECR/ECN INFORMATION: EC No: 109530 DATE: 2016 / 10 / 19	TITLE: <b>TEST SUMMARY FOR 46235 LOW FORCE MICRO-FIT CONNECTOR SYSTEM</b>	SHEET No. <b>11 of 18</b>
DOCUMENT NUMBER: <b>TS-46235-001</b>	CREATED / REVISED BY: <b>JDFOX</b>	CHECKED BY: <b>SSOUSEK</b>	APPROVED BY: <b>FSMITH</b>

# TEST SUMMARY

## 5.1 ELECTRICAL/ENVIRONMENTAL PERFORMANCE RESULTS (cont)

15μ" Au – 250 cycles (lubricated)				
ITEM	DESCRIPTION	TREATMENT	REQUIREMENT	RESULTS
<b>G R O U P  7</b>	Dielectric Withstanding Voltage (DWV)	Durability (250 M/U cycles) 2200 VAC	No breakdown or flashover	PASS

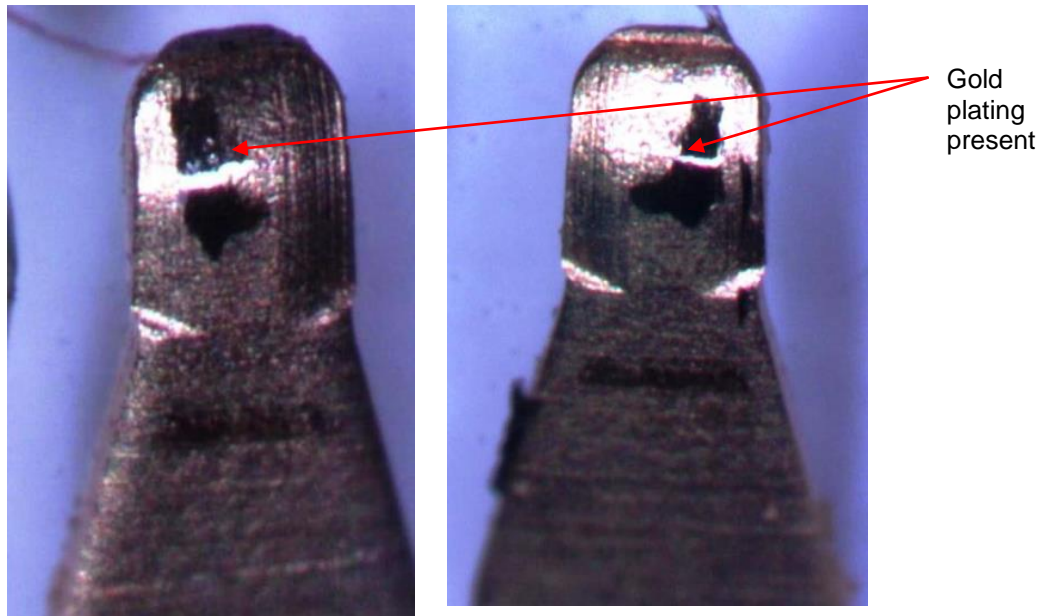

Figure 3 – Contact area shown after 250 cycles

REVISION: <b>D1</b>	ECR/ECN INFORMATION: EC No: 109530 DATE: 2016 / 10 / 19	TITLE: <b>TEST SUMMARY FOR 46235 LOW FORCE MICRO-FIT CONNECTOR SYSTEM</b>	SHEET No. <b>12 of 18</b>
DOCUMENT NUMBER: <b>TS-46235-001</b>	CREATED / REVISED BY: <b>JDFOX</b>	CHECKED BY: <b>SSOUSEK</b>	APPROVED BY: <b>FSMITH</b>



# TEST SUMMARY

## 5.2 MECHANICAL PERFORMANCE RESULTS

ITEM	DESCRIPTION	TREATMENT	REQUIREMENT	MEAN	MINIMUM	MAXIMUM
<b>1a</b>	<b>2 circuit</b> Connector Mate and Unmate Forces (W-B, 15 $\mu$ " Au) <i>**thumb latch removed**</i>	Initial Mating	8.0 N maximum	5.52 N	3.81 N	6.88 N
		Initial Un-Mating	4.0 N maximum	2.93 N	2.43 N	3.57 N
		Final Mating (after 40 cycles)	8.0 N maximum	4.71 N	3.40 N	5.30 N
		Final Un-Mating (after 40 cycles)	4.0 N maximum	3.51 N	1.63 N	4.06 N
<b>1b</b>	<b>2 circuit</b> Connector Mate and Unmate Forces (W-W, 15 $\mu$ " Au) <i>**thumb latch removed**</i>	Initial Mating	8.0 N maximum	5.03 N	4.67 N	5.46 N
		Initial Un-Mating	4.0 N maximum	2.30 N	2.13 N	2.58 N
		Final Mating (after 40 cycles)	8.0 N maximum	3.59 N	3.27 N	3.87 N
		Final Un-Mating (after 40 cycles)	4.0 N maximum	2.32 N	2.10 N	2.51 N
<b>1c</b>	<b>12 circuit</b> Connector Mate and Unmate Forces (W-B, 15 $\mu$ " Au) <i>**thumb latch removed**</i>	Initial Mating	48.0 N maximum	15.32 N	13.78 N	17.00 N
		Initial Un-Mating	24.0 N maximum	9.79 N	7.83 N	13.15 N
		Final Mating (after 40 cycles)	48.0 N maximum	16.81 N	14.74 N	20.44 N
		Final Un-Mating (after 40 cycles)	24.0 N maximum	13.76 N	11.22 N	16.38 N
<b>1d</b>	<b>12 circuit</b> Connector Mate and Unmate Forces (W-W, 15 $\mu$ " Au) <i>**thumb latch removed**</i>	Initial Mating	48.0 N maximum	29.39 N	21.65 N	34.27 N
		Initial Un-Mating	24.0 N maximum	18.10 N	13.22 N	21.98 N
		Final Mating (after 40 cycles)	48.0 N maximum	24.12 N	19.84 N	28.23 N
		Final Un-Mating (after 40 cycles)	24.0 N maximum	19.69 N	14.57 N	23.78 N

REVISION: <b>D1</b>	ECR/ECN INFORMATION: EC No: 109530 DATE: 2016 / 10 / 19	TITLE: <b>TEST SUMMARY FOR 46235 LOW FORCE MICRO-FIT CONNECTOR SYSTEM</b>	SHEET No. <b>13 of 18</b>
DOCUMENT NUMBER: <b>TS-46235-001</b>	CREATED / REVISED BY: <b>JDFOX</b>	CHECKED BY: <b>SSOUSEK</b>	APPROVED BY: <b>FSMITH</b>



# TEST SUMMARY

## 5.2 MECHANICAL PERFORMANCE RESULTS (cont)

ITEM	DESCRIPTION	TREATMENT	REQUIREMENT	MEAN	MINIMUM	MAXIMUM
<b>1e</b>	<b>24 circuit Connector Mate and Unmate Forces (W-B, 15μ" Au) <i>**thumb latch removed**</i></b>	Initial Mating	96.0 N maximum	<b>37.93 N</b>	<b>33.42 N</b>	<b>42.50 N</b>
		Initial Un-Mating	48.0 N maximum	<b>21.82 N</b>	<b>19.98 N</b>	<b>23.35 N</b>
		Final Mating (after 40 cycles)	96.0 N maximum	<b>34.04 N</b>	<b>31.42 N</b>	<b>36.26 N</b>
		Final Un-Mating (after 40 cycles)	48.0 N maximum	<b>25.35 N</b>	<b>23.77 N</b>	<b>27.13 N</b>
<b>1f</b>	<b>24 circuit Connector Mate and Unmate Forces (W-W, 15μ" Au) <i>**thumb latch removed**</i></b>	Initial Mating	96.0 N maximum	<b>52.61 N</b>	<b>47.20 N</b>	<b>61.89 N</b>
		Initial Un-Mating	48.0 N maximum	<b>29.87 N</b>	<b>27.53 N</b>	<b>32.68 N</b>
		Final Mating (after 40 cycles)	96.0 N maximum	<b>43.80 N</b>	<b>40.78 N</b>	<b>45.15 N</b>
		Final Un-Mating (after 40 cycles)	48.0 N maximum	<b>36.45 N</b>	<b>32.49 N</b>	<b>39.52 N</b>

REVISION: <b>D1</b>	ECR/ECN INFORMATION: EC No: <b>109530</b> DATE: <b>2016 / 10 / 19</b>	TITLE: <b>TEST SUMMARY FOR 46235 LOW FORCE MICRO-FIT CONNECTOR SYSTEM</b>	SHEET No. <b>14 of 18</b>
DOCUMENT NUMBER: <b>TS-46235-001</b>	CREATED / REVISED BY: <b>JDFOX</b>	CHECKED BY: <b>SSOUSEK</b>	APPROVED BY: <b>FSMITH</b>



# TEST SUMMARY

## 5.2 MECHANICAL PERFORMANCE RESULTS (cont)

ITEM	DESCRIPTION	TREATMENT	REQUIREMENT	MEAN	MINIMUM	MAXIMUM
2	Terminal Retention Force (in housing)	-----	24.5 N per contact minimum	36.4 N	35.4 N	37.9 N
3	Terminal Insertion Force (in housing)	-----	14.7 N per contact maximum	2.9 N	2.2 N	4.2 N
4	Wire Pullout Force (from terminal)	20 awg	57.8 N minimum	107.4 N	97.0 N	116.0 N
		22 awg	35.6 N minimum	80.7 N	71.8 N	86.0 N
		24 awg	22.2 N minimum	50.45 N	46.0 N	56.0 N
		26 awg	13.3 N minimum	28.7 N	24.0 N	31.0 N
		28 awg	8.9 N minimum	17.1 N	15.0 N	19.0 N
		30 awg	6.6 N minimum	9.4 N	9.0 N	10.0 N
5	Normal Force (nominal deflection)	Initial	50 g per contact beam minimum	134.8 g	120.8 g	143.3 g
		After one cycle	50 g per contact beam minimum	134.3 g	121.8 g	143.6 g

REVISION: <b>D1</b>	ECR/ECN INFORMATION: EC No: 109530 DATE: 2016 / 10 / 19	TITLE: <b>TEST SUMMARY FOR 46235 LOW FORCE MICRO-FIT CONNECTOR SYSTEM</b>	SHEET No. <b>15 of 18</b>
DOCUMENT NUMBER: <b>TS-46235-001</b>	CREATED / REVISED BY: <b>JDFOX</b>	CHECKED BY: <b>SSOUSEK</b>	APPROVED BY: <b>FSMITH</b>



# TEST SUMMARY

## 6.0 APPENDIX 1

### 6.1 TEST SEQUENCES

GROUP 1	GROUP 2	GROUP 3	GROUP 4	GROUP 5	GROUP 7
Visual Exam	Visual Exam	Visual Exam	Visual Exam	Visual Exam	Visual Exam
LLCR	LLCR	LLCR	LLCR	LLCR	LLCR
Preconditioning Durability (25 M/U cycles)	Preconditioning Durability (25 M/U cycles)	Preconditioning Durability (25 M/U cycles)	Preconditioning Durability (25 M/U cycles)	Preconditioning Durability (25 M/U cycles)	Durability (40 M/U cycles)
LLCR	LLCR	Temp Life (120 hrs @ 105°)	LLCR	LLCR	LLCR
Temp Life (240 hrs @ 105°)	Thermal Shock	LLCR	Temp Life (120 hrs @ 105°)	Temp Life (120 hrs @ 105°)	DWV
LLCR	LLCR	Vibration	LLCR	LLCR	Visual Exam
Reseating	Cyclic Temp and Humidity	LLCR	MFG (7 days Unmated)	Thermal Cycling	
LLCR	LLCR	Mechanical Shock	LLCR	LLCR	
	Reseating	LLCR	MFG (3 days Mated)	Thermal Shock	
	LLCR		LLCR	LLCR	
			Thermal Shock	Reseating	
			LLCR	LLCR	
			Reseating		
			LLCR		

REVISION: <b>D1</b>	ECR/ECN INFORMATION: EC No: 109530 DATE: 2016 / 10 / 19	TITLE: <b>TEST SUMMARY FOR 46235 LOW FORCE MICRO-FIT CONNECTOR SYSTEM</b>	SHEET No. <b>16 of 18</b>
DOCUMENT NUMBER: <b>TS-46235-001</b>	CREATED / REVISED BY: <b>JDFOX</b>	CHECKED BY: <b>SSOUSEK</b>	APPROVED BY: <b>FSMITH</b>





# TEST SUMMARY

## 6.2 TEST PROCEDURES

<u>ITEM</u>	<u>TEST CONDITION</u>
LOW LEVEL CONTACT RESISTANCE (LLCR)	per EIA-364-TP-23
INITIAL MATING FORCE	per EIA-364-TP-13
INITIAL UN-MATING FORCE	per EIA-364-TP-13
DURABILITY	per EIA-364-TP-09
RANDOM VIBRATION	per EIA-364-TP-28, Test Cond. VII
MECHANICAL SHOCK	per EIA-364-TP-27 Peak Value: 50 G; Duration: 11 mSec.; Waveform: Half Sine; # Shocks Direction: 3 shocks/3 axes (18 total)
NORMAL FORCE	per EIA-364-04 (perpendicular force)
THERMAL AGING (Temp life)	per EIA-364-TP-17, method A
THERMAL SHOCK	per EIA-364-TP-32
CYCLIC HUMIDITY	per EIA-364-TP-31 Test Temp: +40° ± 2° C Relative Humidity: 90 to 95%; Test Duration: 96 hours
MIXED FLOWING GAS (MFG)	per EIA-364-TP-65, Option 2, Class IIA
Dielectric Withstanding Voltage (DWV)	per EIA-364-TP-20 Method B
Insulation Resistance	per EIA-364-TP-21
Current Carrying Capacity (CCC)	per EIA-364-TP-70 Method 2

REVISION: <b>D1</b>	ECR/ECN INFORMATION: EC No: 109530 DATE: 2016 / 10 / 19	TITLE: <b>TEST SUMMARY FOR 46235 LOW FORCE MICRO-FIT CONNECTOR SYSTEM</b>	SHEET No. <b>17 of 18</b>
DOCUMENT NUMBER: <b>TS-46235-001</b>	CREATED / REVISED BY: <b>JDFOX</b>	CHECKED BY: <b>SSOUSEK</b>	APPROVED BY: <b>FSMITH</b>



# TEST SUMMARY

## 7.0 REVISION HISTORY

Revision Level:	Created / Revised By:	Revision Description:	Date of Revision
A	T. Gregori	Initial "A" Release	7/09/08
B	T. Gregori	Revised Group 4 data based on test results, section 5.1	7/28/08
C	T. Gregori	T-Rise table added; Group 7 250 cycle table added	11/20/08
D	T. Gregori	Revised mate / un-mate force; added total forces for 2, 12 and 24 ckts (items 1a thru 1f)	8/5/09
D1	JDFOX	Add series detail to sections 2.1 & 2.1.1	10/19/16

REVISION: <b>D1</b>	ECR/ECN INFORMATION: EC No: 109530 DATE: 2016 / 10 / 19	TITLE: <b>TEST SUMMARY FOR 46235 LOW FORCE MICRO-FIT CONNECTOR SYSTEM</b>	SHEET No. <b>18 of 18</b>
DOCUMENT NUMBER: <b>TS-46235-001</b>	CREATED / REVISED BY: <b>JDFOX</b>	CHECKED BY: <b>SSOUSEK</b>	APPROVED BY: <b>FSMITH</b>